

RS Quest

Rigging Manual V8











RS Quest

Contents

1. Components	1-6
1.1 - Spars	1
1.2 - Rudder pack	1
1.3 - Rigging pack	2
1.4 - Rope pack	3
1.5 - Asymmetrical spinnaker pack	4
1.6 - Symmetrical spinnaker pack	5
1.7 - Asymmetrical spinnaker rope pack	6
1.8 - Symmetrical spinnaker rope pack	6
1.9 - Foredeck pack	6
2. Introduction	7
3. Preparation	8
4. Hull	9-23
4.1 - Toestraps	10-11
4.2 - Shroud eye bolts	11
4.3 - Asymmetrical spinnaker fittings	12-16
4.4 - Symmetrical spinnaker fittings	17-21
4.5 - Adding the spinnaker sock	22-23
5. Foredeck	24-27
5.1 - Attaching the foredeck	25-26
5.2 - Adjusting the trolley for extra foredeck weight	27
6. Mast	28-40
6.1 - Jointing the mast sections	29
6.2 - Fitting the spreaders to the mast	29
6.3 - Attaching the shrouds	30
6.4 - Spreader ends	30
6.5 - Main halyard	31
6.6 - Jib halyard	31
6.7 - Forestay	32
6.8 - Spinnaker halyard take-up elastic	32-33
6.9 - Spinnaker halyard mast turning blocks	33-34
6.10 - Masthead float	35
6.11 - Shrouds	36-37
6.12 - Stepping the mast	38-39
6.13 - Forestay	40
6.14 - Rig tensioning	40
7. Boom	41-45
7.1 - Fitting the boom	42
7.2 - Gnav control line	43
7.3 - Mainsheet	44-45
8. Sails	46 - 55
8.1 - Preparing the sails	47-48
8.2 - Battens	48
8.3 - Sail care	48
8.4 - Hoisting the jib	49-51
8.5 - Outhaul	52
8.6 - Hoisting the mainsail	53-54
8.7 - Downhaul	55
8.8 - Mainsail tack strap	55
9. Gennaker/Spinnaker	56-65
9.1 - Rigging the asymmetric spinnaker	57-60
9.2 - Rigging the symmetrical spinnaker	61-64
9.3 - Spinnaker pole	65-67
10. Foils	68-70
10.1 - Rudder	69-70
10.2 - Centreboard	70
11. Reefing	71-74
11.1 - Rigging the reefing line	72
11.2 - Reefing the mainsail	73-7
12. Trapeze Kit	75-78
13. Outboard bracket	79-81
1. Sailing Hints	82-88



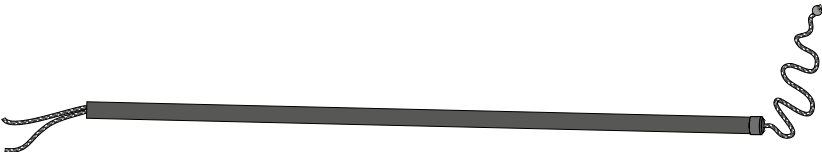





RS Quest 1.1 - Spars

	QUANTITY	COMPONENT
	1	Lower mast
	2	Spreader
	2	Spreader end
	2	Clevis pin
	2	Split ring
	1	Upper mast
	1	Boom and gnav
	1 (optional)	Spinnaker pole
	1 (optional)	Bowsprit

RS Quest 1.2 - Rudder pack



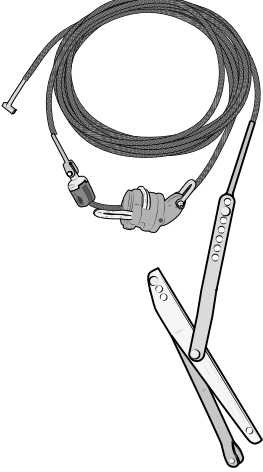
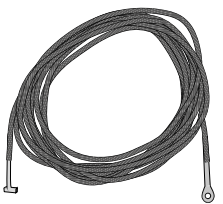



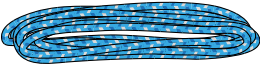

	QUANTITY	COMPONENT
	1	Rudder
	1	Tiller
	1	Tiller extension
	2	Screws

RS Quest 1.3 - Rigging Pack



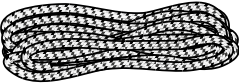









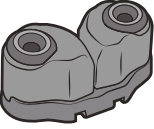

	QUANTITY	COMPONENT
	2	Shroud eye bolts
	2	Shroud recess bars
	1	Plastic bobble (jib halyard)
	2	Shroud adjuster plate
	1	30mm block (jib halyard)
	1	40mm block with becket (mainsheet)
	1	Forestay
	2	Shrouds
	2	Shroud vernier covers

April 2017 onwards















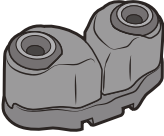

RS Quest 1.4 - Rope Pack

	QUANTITY	COMPONENT
	1	Jib halyard
	1	Main halyard
	1	Mainsheet strop
	1	Jibsheet
	1	Mainsheet
	1	Reefing line
	1	Cunningham (downhaul)
	1	Outhaul





RS Quest 1.5 - Asymmetric Spinnaker Pack

	QUANTITY	COMPONENT
	8	M5 X 8mm bolt
	2	M4 x 25mm bolt
	1	Metal ring
	1	Plastic bobble
	1	Metal eyelet
	1	Cleat
	1	Cleat base
	1	Bow turning block
	1	M4 x 25mm bolt
	1	M4 x 12mm bolt
	1	30mm block
	2	Ratchet block
	3	30mm block with shackle, spring and eyelet
	1	30mm block with shackle (Spinnaker halyard)
	1	Spinnaker halyard takeup elastic





RS Quest 1.6 - Symmetrical Spinnaker Pack

	QUANTITY	COMPONENT
	10	M5 X 8mm bolt
	6	M4 x 25mm bolt
	4	M5 x 35mm bolt
	4	Size 8 x 3/4" pan head screws
	6	Size 10 x 1" pan head screws
	2	Large cleat
	3	Cleat
	1	Cleat base
	4	Metal eyelet
	2	Large metal eyelet
	2	Ratchet block
	3	30mm block with shackle, spring and eyelet
	1	30mm block with shackle (spinnaker halyard)
	3	Plastic bobble
	3	Metal ring
	1	Pole retainer wire
	1	Spinnaker halyard takeup elastic





RS Quest 1.7 - Asymmetric Spinnaker Rope Pack

	QUANTITY	COMPONENT
	1	Spinnaker sock elastic tie
	1	Spinnaker takeup elastic
	1	Spinnaker sheet
	1	Spinnaker halyard

RS Quest 1.8 - Symmetrical Spinnaker Rope Pack

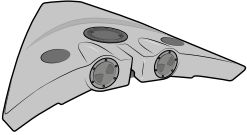
	QUANTITY	COMPONENT
	1	Spinnaker sock elastic tie
	1	Spinnaker takeup elastic
	1	Spinnaker sheet
	1	Spinnaker halyard
	1	Twinning line

RS Quest 1.9 - Foredeck Pack

	QUANTITY	COMPONENT
	1	Foredeck
	2	M8 x 50mm bolt
	2	Washer
	2	Metal spigot
	4	M5 x 12mm countersunk bolt

2 - Introduction

Congratulations on the purchase of your new RS Quest, and thank you for choosing an RS product. We are confident that you will have many hours of great sailing and racing in this truly excellent design. The RS Quest is an exciting boat to sail and offers fantastic sailability and performance. This manual has been compiled to help you to gain the maximum enjoyment from your RS Quest, in a safe manner. It contains details of the craft, the equipment supplied or fitted, its systems, and information on its safe operation and maintenance. Please read this manual carefully and be sure that you understand its contents before using your RS Quest.

This manual will not instruct you in boating safety or seamanship. If this is your first boat, or if you are changing to a type of craft that you are not familiar with, for your own safety and comfort, please ensure that you have adequate experience before assuming command of the craft. If you are unsure, RS, your RS Dealer, or your national sailing federation – for example, the Royal Yachting Association – will be able to advise you of a local sailing school, or a competent instructor.

RS Sailing highly recommends using RS supplied equipment for usage and storing of your craft. Deviation from using RS supplied equipment, such as sails and storage solutions, will require consultation with RS Sailing. Failure to do so may affect Warranty claims and Goodwill outcomes.

Please keep this manual in a secure place and hand it over to the new owner if you sell the boat.

For further information, spares, and accessories, please contact:

RS Sailing
Premier Way
Abbey Park
Romsey
Hampshire SO51 9DQ
Tel: +44 (0)1794 526760
Email: info@RSSailing.com

For details of your local RS Dealer, please visit www.RSSailing.com

3 - Preparation

Your RS Quest comes complete with all the components necessary to take the boat sailing. In order to commission it, you will need the following tools:

- Pliers or a shackle key
- Small, flat-bladed screw driver
- PVC electrician's tape
- Pozi-drive screwdriver
- Adjustable spanner (small)

Including adding a spinnaker system please allow three hours to fully prepare your Quest.

Whilst your RS Quest has been carefully prepared, it is important that new owners should check that shackles and knots are tight. This is especially important when the boat is new, as traveling can loosen seemingly tight fittings and knots. It is also important to check such items prior to sailing regularly.

If you have ordered the Symmetrical or Asymmetrical spinnaker packs, you will have to fit the components to the boat yourself, as shown in sections **4.3** and **4.4**.

To simplify the commissioning process, please take care when unpacking the items from the boat as cross contamination of pack contents can cause confusion. A calm and orderly environment will assist the process.

RS Quest

Rigging Guide

4 - Hull



PLEASE FOLLOW RIGGING GUIDE IN CORRECT ORDER

RS Quest

RS Quest 4.1 - Toestraps

Start by attaching the toestraps to the thwart across the middle of the cockpit.

To do this you will need a pozidrive screwdriver.

Make sure you attach the toestraps the right way round. The ends with the webbing loop attach to the thwart. The ends with the buckle **DO NOT** attach to the thwart.

The forward toestraps are separate and the aft toestraps are joined together in a V shape.

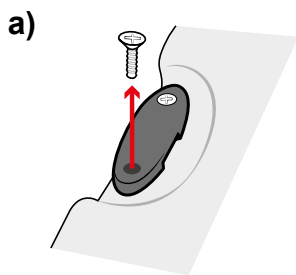
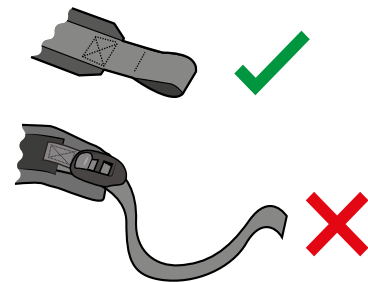
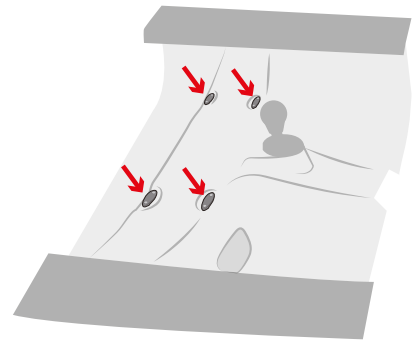
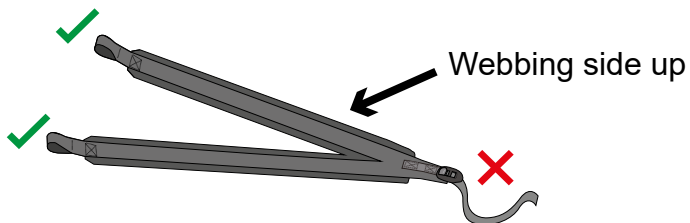

Remove **ONE** of the screws from the toetraps retainer on the thwart.

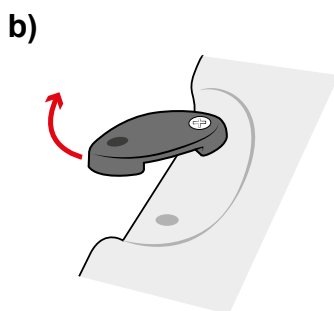

Rotate the toetraps retainer outwards to allow you to slide the webbing loop on the toetraps over it.

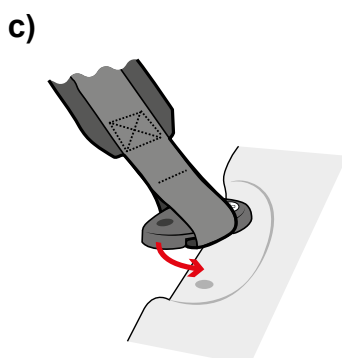
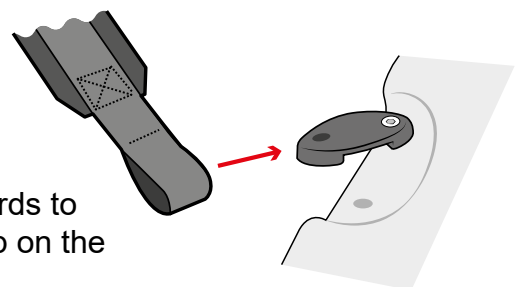

Rotate the toetraps retainer back into position and replace the screw.

Repeat for all four toetraps retainers on the thwart.

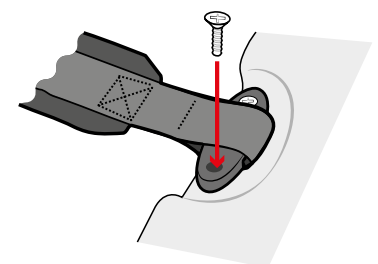

RS Quest 4.1 - Toestraps

d) You can now attach the two forward toestrap ends and one aft toestrap end to the toestrap retainers using the buckle.

e) There are two elastics emerging from the track on the mast support beam.

Tie one of these elastics to each of the front toestraps through the webbing loop behind the buckle.

RS Quest 4.2 - Shroud eye bolts

a) Find the two shroud eye bolts and recess bars.

Hold the recess bar beneath the gunwhale and make sure the holes are aligned

Screw the shroud eye bolt through. Tighten by hand and then give one further turn using a screwdriver through the shroud eye bolt.

Repeat on the other side of the boat.

b) Add the shroud adjuster plates through the shroud eye bolts on either side of the boat. Temporarily attach using the clevis pin and split ring surrounded.

Start at hole 3

RS Quest 4.3 - Asymmetric spinnaker fittings.

If you have purchased the asymmetric spinnaker pack **(which is available as an option)**, there are a number of fittings that must be added before you can rig the boat.

To complete this section you will need:

- Asymmetric spinnaker kit
- Pozidrive screwdriver



If you have purchased the optional foredeck, do not add it until all fittings have been attached to the boat.

a) Spinnaker Rear Halyard Block

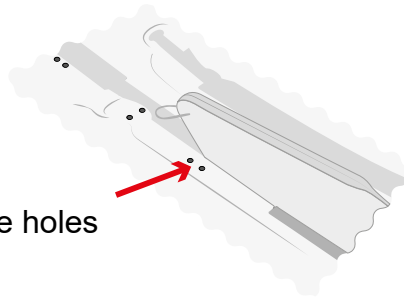

Remove the black plastic plugs from the holes just to the port side of the centreboard.

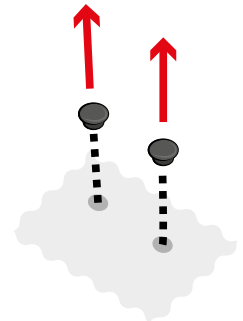

b)

Screw a 30mm block from the asymmetric spinnaker kit into these holes using the two M5 x 8mm bolts provided.

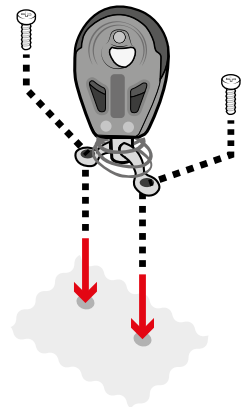

c) Spinnaker Halyard Cleat

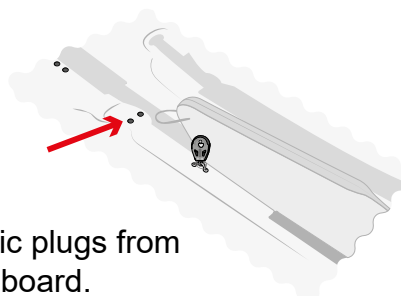

Remove the next set of black plastic plugs from the holes just forward of the centreboard.

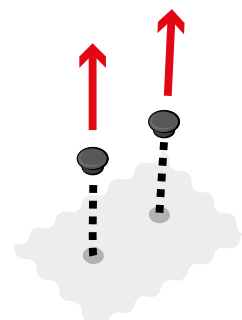

RS Quest 4.3 - Asymmetric spinnaker fittings.

d)

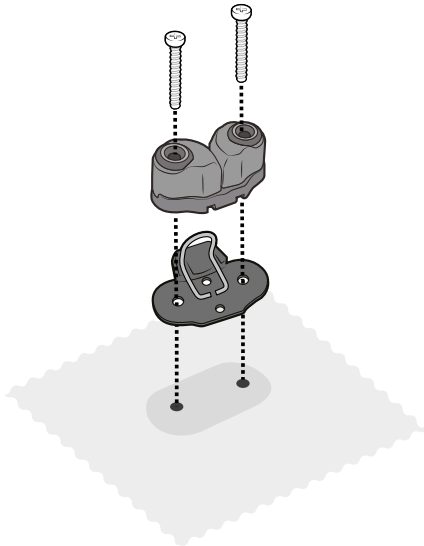

Attach the spinnaker halyard cleat using the M4 x 25mm bolts provided.



Make sure cleat opens towards the stern of the boat.



If overtightened the jaws may not close properly.

e) Spinnaker Halyard Block Front.

Remove the plastic plugs from the next set of holes.

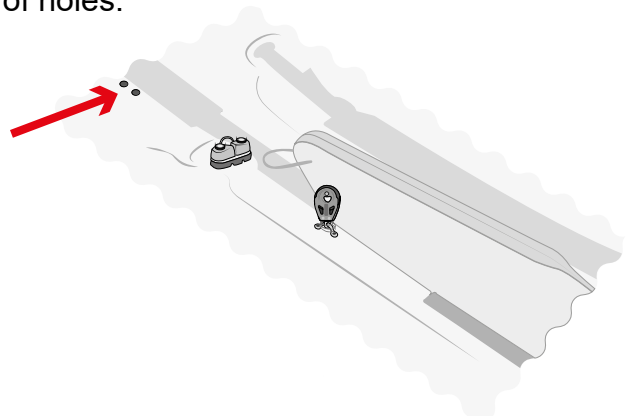
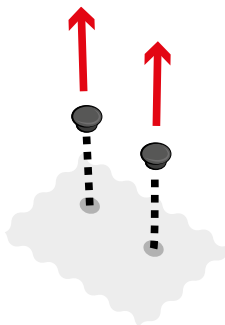

f)

Screw a 30mm block from the asymmetric spinnaker kit into these holes using the two M5 x 8mm bolts provided.

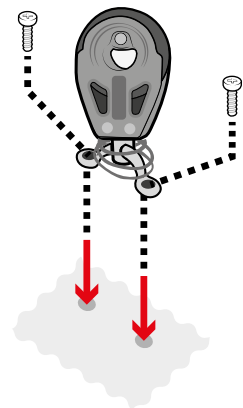

RS Quest 4.3 - Asymmetric spinnaker fittings.

g)

Remove the two black plastic plugs from the holes on the port side of the cockpit.

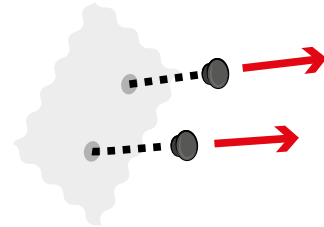
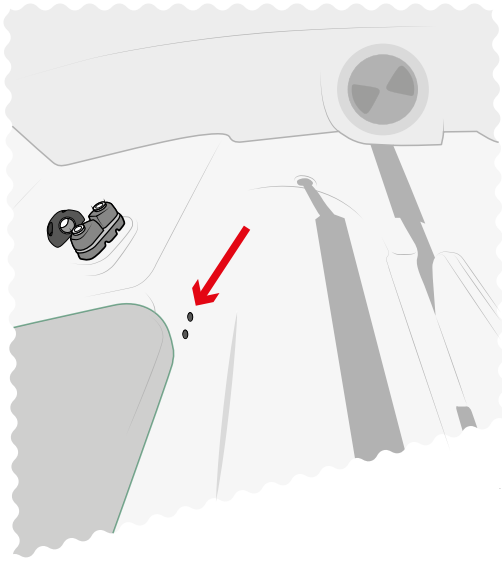

h) Spinnaker Retrieval Block

Screw a 30mm block from the asymmetric spinnaker kit into these holes using the two M5 x 8mm bolts provided.

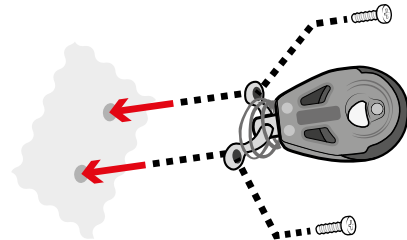

i) Spinnaker pole outhaul block

Remove the two black plastic plugs which are just to the port side of the front end of the spinnaker pole channel.

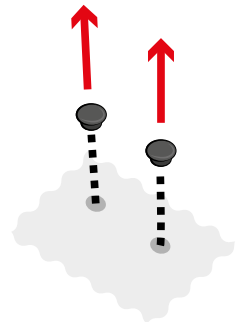
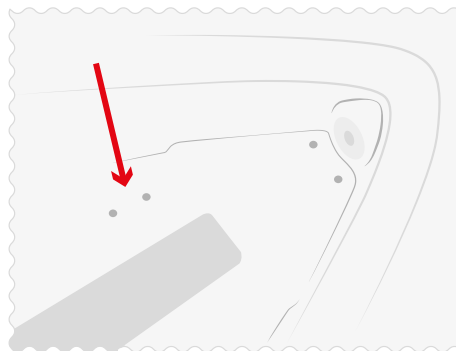
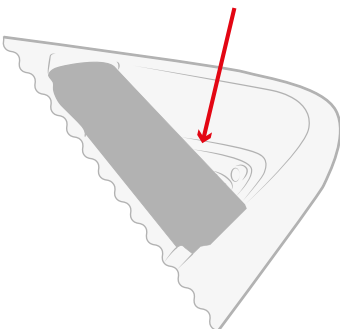

RS Quest 4.3 - Asymmetric spinnaker fittings.

j) Add the turning block using the screws provided.

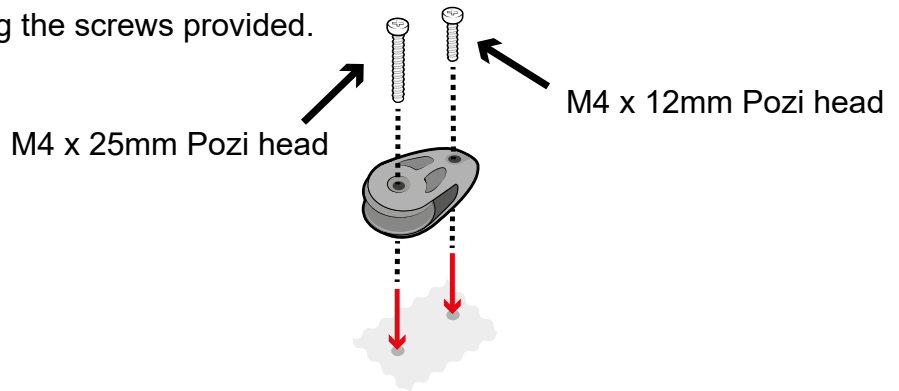

k) Tack Line Eyelet

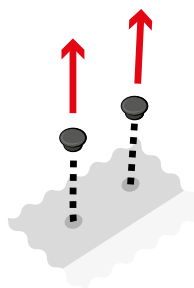

Remove the two black plastic plugs from the holes in the channel that runs forwards from in front of the centreboard case.

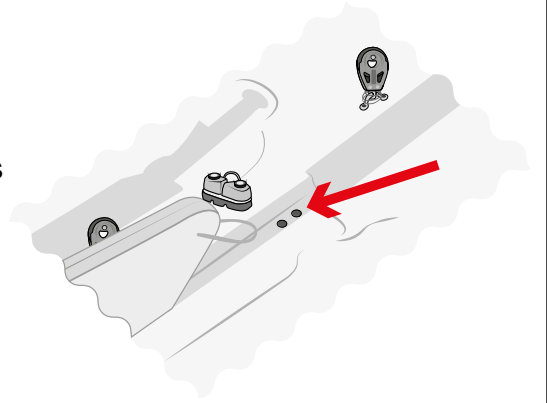

l)

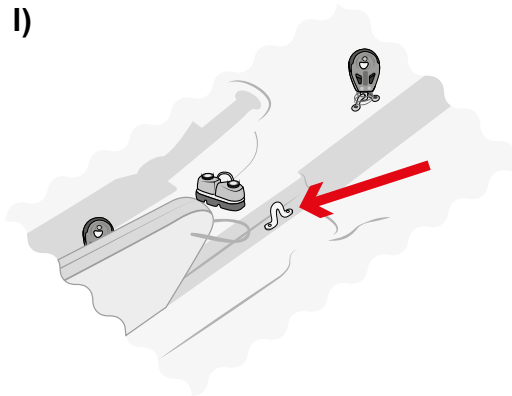

Add the metal eyelet from the asymmetric spinnaker kit using the two M5 x 8mm screws provided.

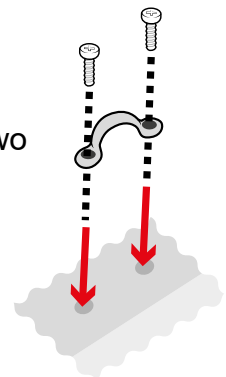

m) Adding the Spinnaker Pole

The inboard end of the bowsprit has two ropes emerging from it. The outboard end has one rope with a plastic stopper on it. In order to insert the inboard end into the boat you will have to remove the launch line (the rope coming out of the side). Insert the bowsprit, inboard end first, into the hole in the bow of the boat.



Once inserted you should reattach the launch line to the bowsprit.

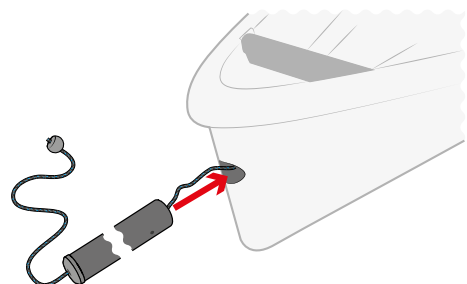
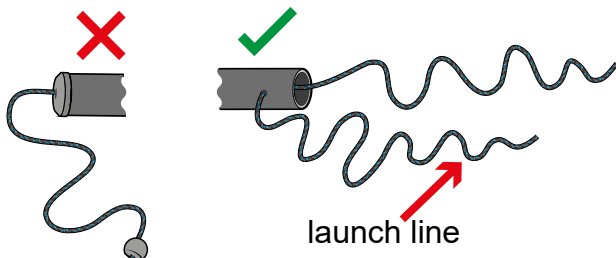

RS Quest 4.3 - Asymmetric spinnaker fittings.

n) Rigging the Tack Line

Make sure that the bowsprit is fully extended.

boats built before April 2017
(pole is 1.65m long)

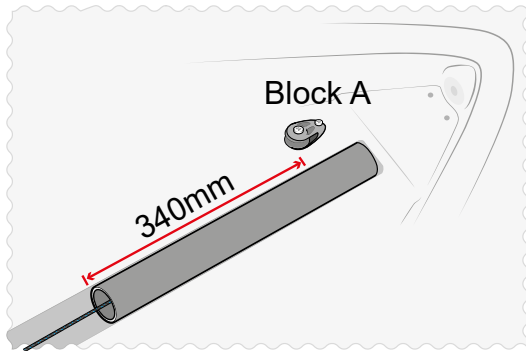

boats built after April 2017
(pole is 1.34m long)

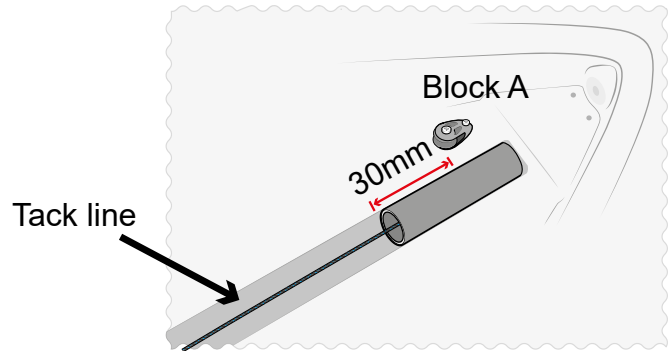

o)

Keeping the bowsprit fully extended, pull the tack line (that emerges from the inboard end of the bowsprit) tight and tie to the eyelet in the bottom of the bowsprit channel with a bowline.

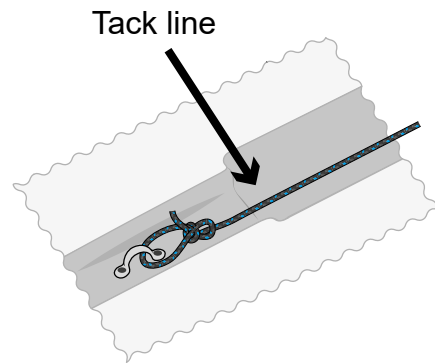

p) Rigging the Launch Line

Take the rope that emerges from the side of the inboard end of the bowsprit and feed it through block A at the bow (from starboard to port).

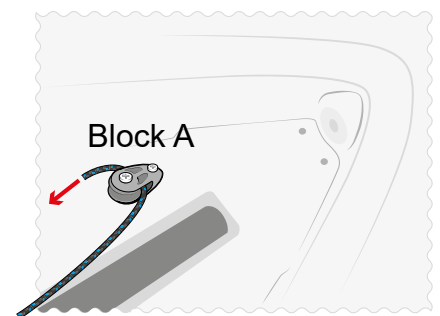
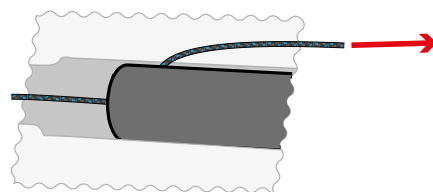

q)

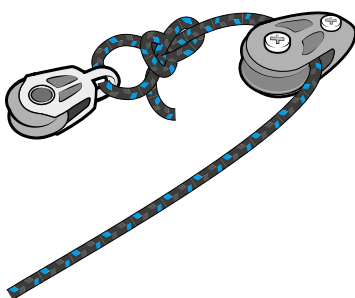

Tie a 30mm block from the asymmetric spinnaker pack onto the end of this rope using a bowline.

Adjust the stopper knot at the other end of this rope so that the bowsprit can retract fully into the boat without the 30mm block hitting block A.



Make sure the 30mm block does not meet up with the halyard block when the pole is extended.

RS Quest 4.4 - Symmetrical Spinnaker Fittings.

If you have purchased the symmetrical spinnaker pack (**which is available as an option**), there are a number of fittings that must be added before you can rig the boat. It is easiest to do this before attaching the foredeck.

To complete this section you will need:

- Symmetrical spinnaker kit
- Pozidrive screwdriver

a) Spinnaker Rear Halyard Block

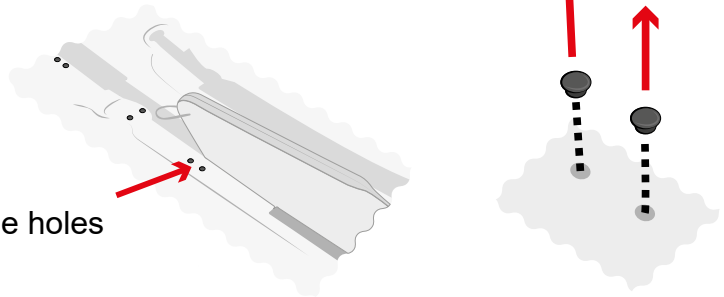

Remove the black plastic plugs from the holes just to the port side of the centreboard.

b)

Screw a 30mm block from the symmetrical spinnaker kit into these holes using the two M5 x 8mm bolts provided.

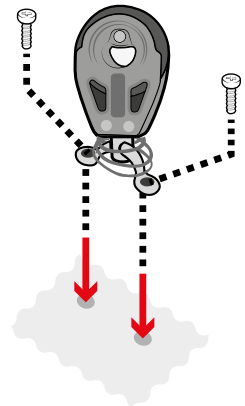

c) Spinnaker Halyard Cleat

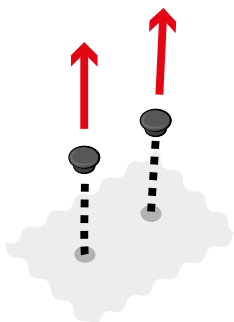

Remove the next set of black plastic plugs from the holes just forward of the centreboard.

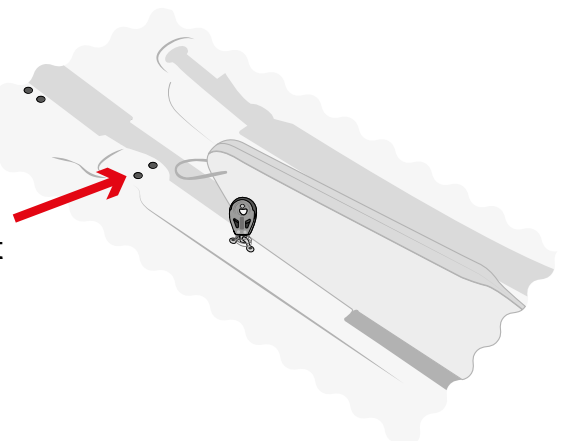

RS Quest 4.4 - Symmetrical Spinnaker Fittings.

d)

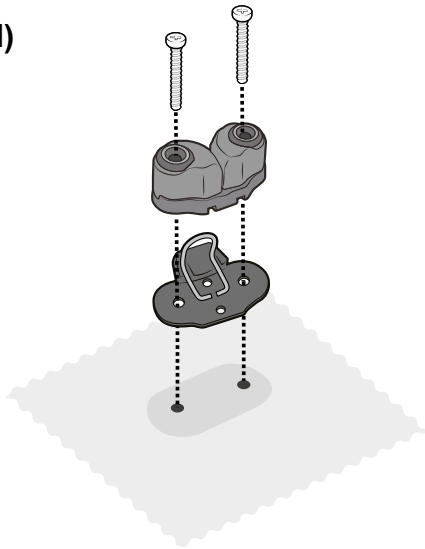

Attach the spinnaker halyard cleat using the M4 x 25mm bolts provided.



Make sure cleat opens towards the stern of the boat.



If overtightened the jaws may not close properly.

e) Spinnaker Front Halyard Block

Remove the plastic plugs from the next set of holes forward.

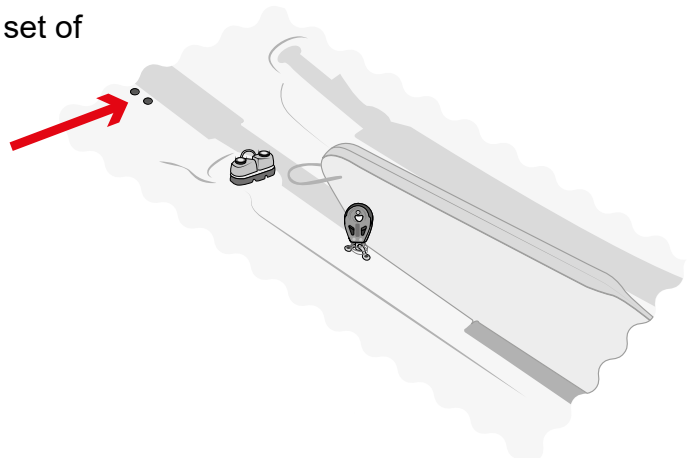
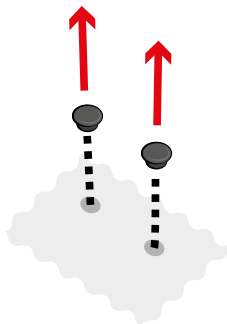

f)

Screw a 30mm block from the symmetrical spinnaker kit into these holes using the two M5 x 8mm bolts provided.

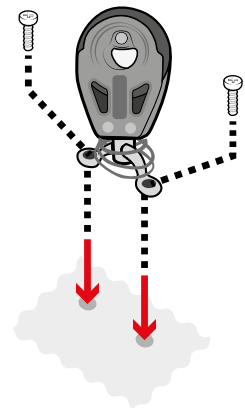

RS Quest 4.4 - Symmetrical Spinnaker Fittings.

g) Spinnaker Retrieval Block

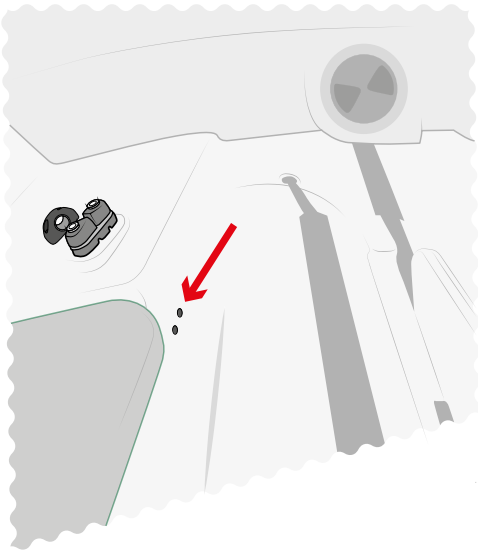

Remove the two black plastic plugs from the holes on the port side of the cockpit.

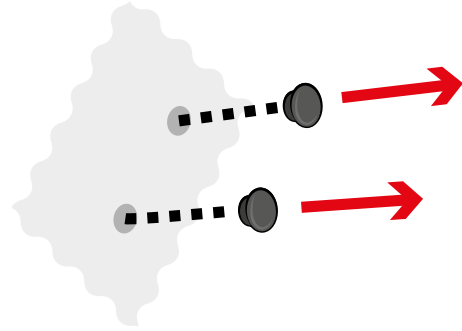

h)

Screw a 30mm block from the symmetrical spinnaker kit into these holes using the two M5 x 8mm bolts provided.

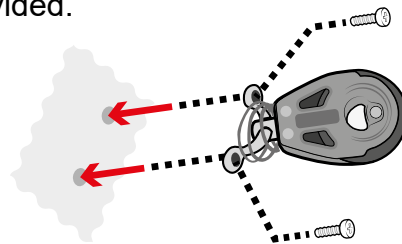

i) Twinning line cleat

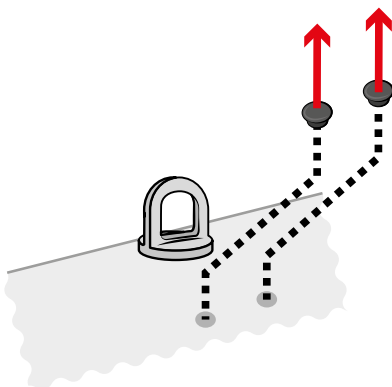

Remove the two black plastic plugs from on top of the gunwhale just inboard of the shroud eye bolts on each side of the boat.

RS Quest 4.4 - Symmetrical Spinnaker Fittings.

j)

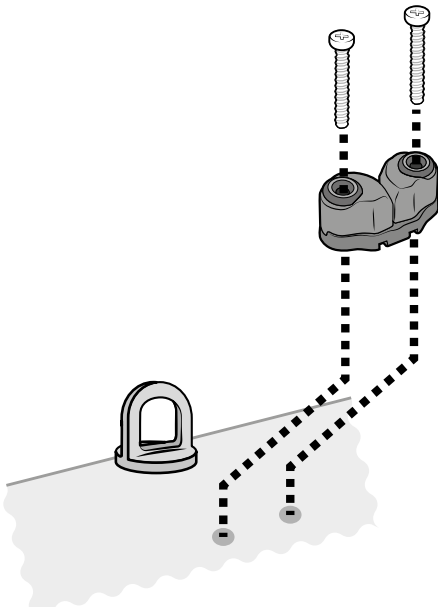

Attach the cleat using the M4 x 25mm bolts provided.



Make sure cleat opens into the boat.



If overtightened the jaws may not close properly.

Repeat on the other side of the boat.

k) Spinnaker Sheet cleat

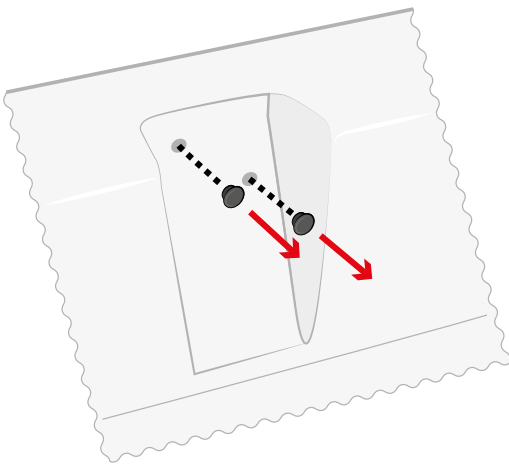

Remove the two black plastic plugs from the holes in the recess half way along the gunwale on both sides of the boat.

l)

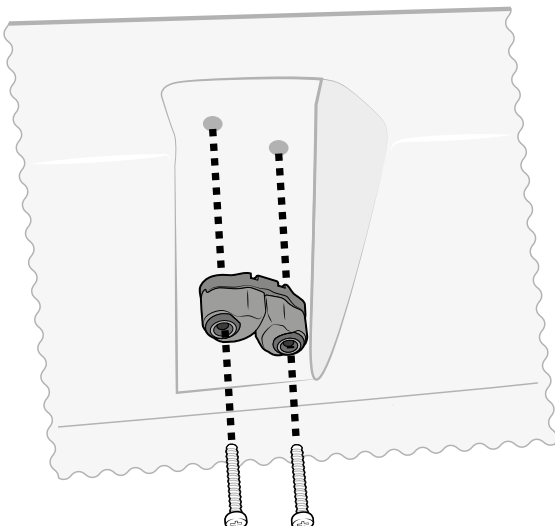

Add a cleat from the symmetrical spinnaker pack using the M5 x 35mm bolts provided.



If overtightened the jaws may not close properly.



Make sure cleat opens upwards.

Repeat on the other side of the boat.

RS Quest 4.4 - Symmetrical Spinnaker Fittings.

m)

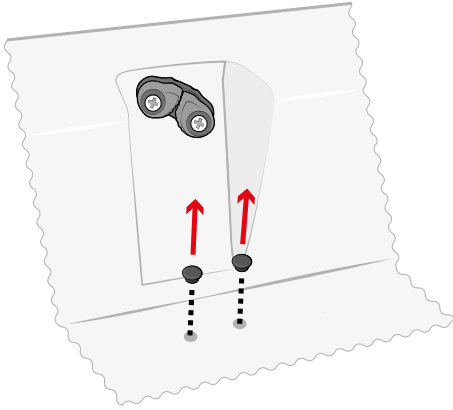

Remove the plastic caps just further inside the boat from the cleats you just added.



Repeat on the other side of the boat.

n)

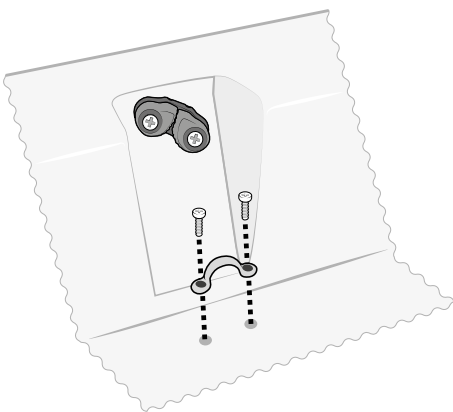

Add a metal eyelet from the symmetrical spinnaker kit using the M5 x 8mm bolts provided.



Repeat on the other side of the boat.

o) Spinnaker Ratchet

Shackle a ratchet block from the symmetrical spinnaker kit onto the eyelet.



Repeat on the other side of the boat.

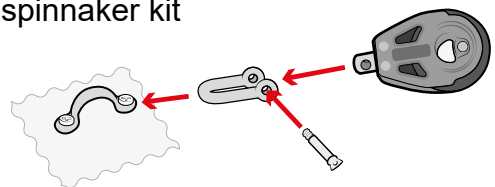

p) Rigging the Twinning Line

Tie a figure of eight knot 1m from each end of the twinning line then add a plastic bobble onto each end of the rope.

Add the twinning line through the shroud eye, from inboard to out, then tie a metal ring on the end with a knot-on-knot.

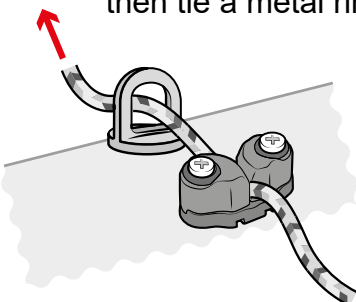

Repeat on the other side of the boat with the other end of the twinning line.

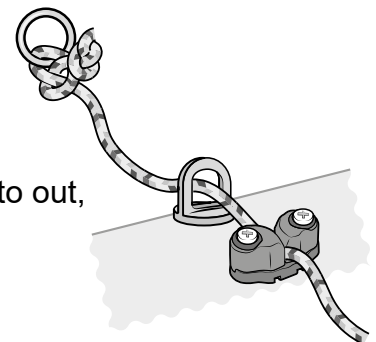

RS Quest 4.5 - Adding the Spinnaker Sock

a)

Remove the two screws and washers from inside the spinnaker chute.

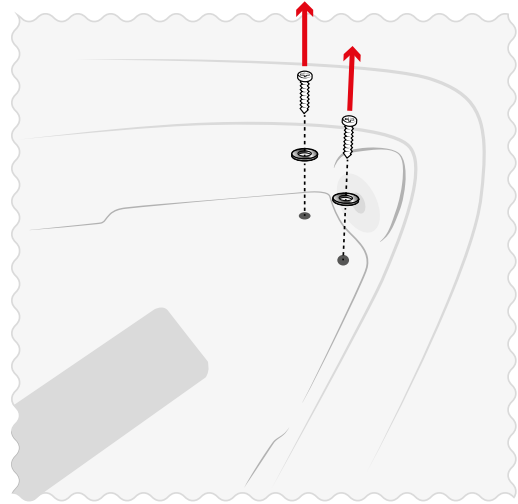
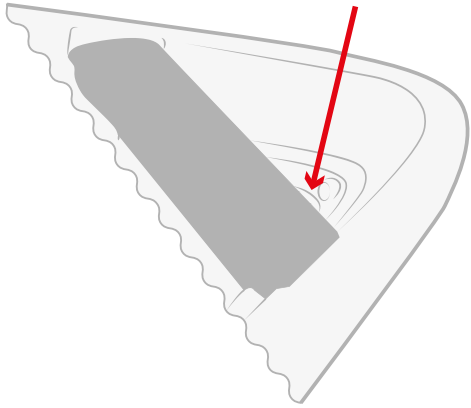

b)

Add the screws through the tongue of the spinnaker sock back into the holes that they came from.

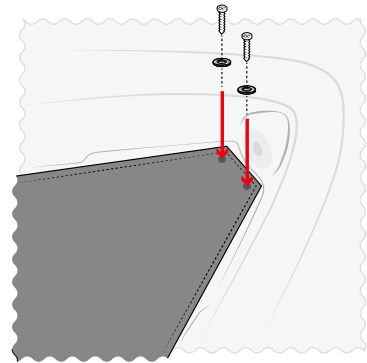

c)

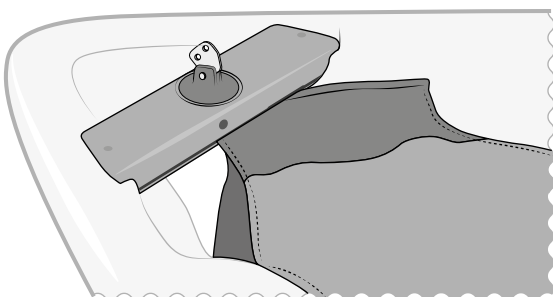
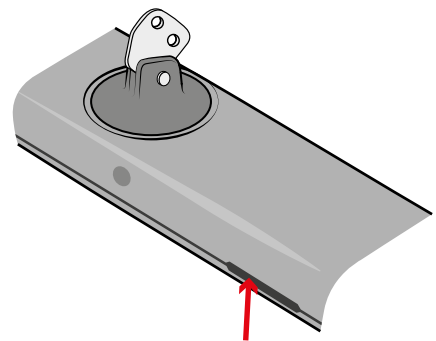
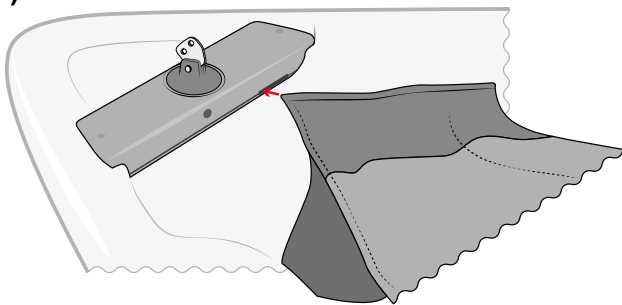

Slide the port side of the front edge of the spinnaker sock into the opening of the track on the tack bar.



This is easier without the foredeck attached.

RS Quest 4.5 - Adding the Spinnaker Sock

d)

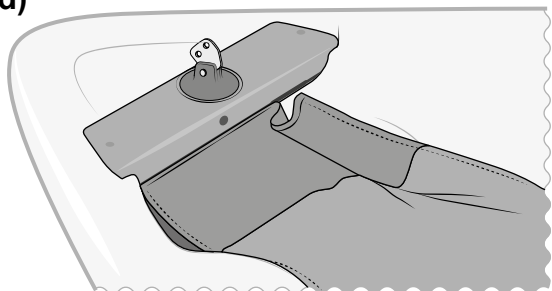

Make sure the port side is fully inserted into the track and then insert the starboard side into the track opening. This can be a little tricky as you will need to bend it back on itself to get to the opening, but as long as the starboard side is fully inserted first it shouldn't be too hard.

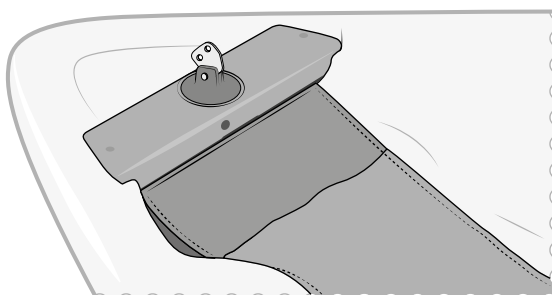

e)

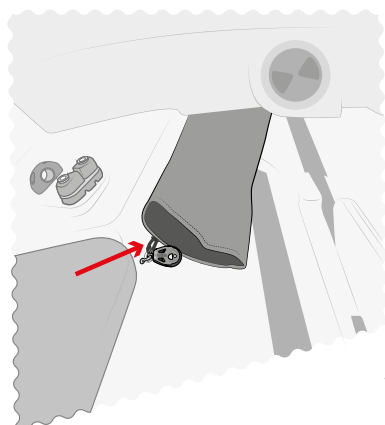

In the spinnaker pack there should be some elastic for the rear of the spinnaker chute.

Use this elastic to tie the aft end of the spinnaker chute to the eyelet (with the 30mm block on it) on the port side of the cockpit.



If you have the foredeck option, you should fit it at this point (See section 5). If not then move on to section 6.

RS Quest

Rigging Guide

5 - Foredeck

To complete this section you will need:

- The foredeck
- A pozidrive screwdriver



PLEASE FOLLOW RIGGING GUIDE IN CORRECT ORDER



Water ingress: The four small compartments are not water tight water will enter and drain. The large compartment may also allow water ingress in the event of a capsized. Valuables / perishables should be placed in a dry bag for maximum protection.

RS Quest 5.1 - Attaching the Foredeck

a)

If you have purchased the foredeck, it will not come attached to the boat. You will have to add it yourself. It is much easier to do this after you have fitted out and rigged the boat for the first time as many of the fittings are difficult to access with the foredeck attached.

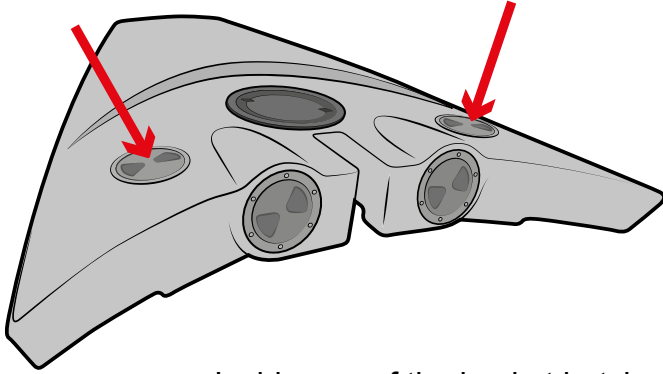

Inside one of the bucket hatches on the foredeck you will find a pack containing all the components you need to attach the foredeck.

b)

Lay the foredeck on its back (hatches down).

Add the two metal spigots in the recesses beneath the front edge of the foredeck using the four M5x18mm bolts provided then turn the foredeck back over.

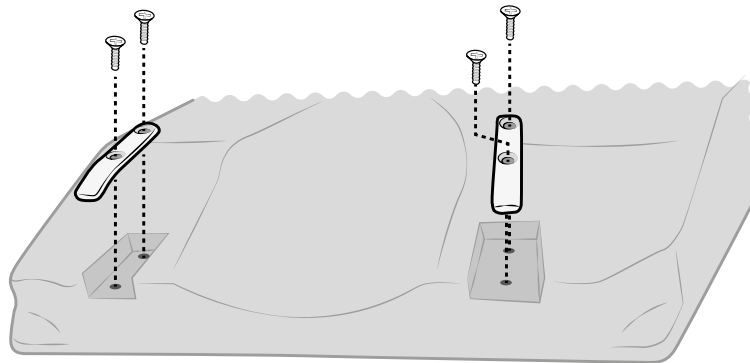

c)

Remove the caps from the two holes in the top of the mast support beam.

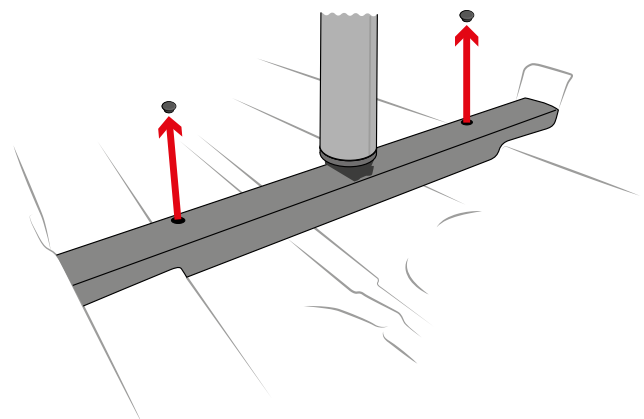

RS Quest 5.1 - Attaching the Foredeck

d)

Pick up the foredeck and locate this into the tack bar making the spigots go into the holes.

Rotate the foredeck down into position.

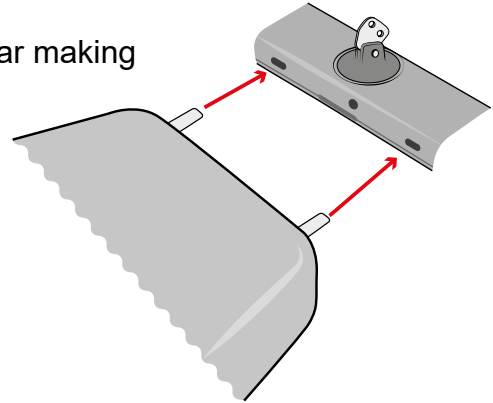

e)

Open the two hatches on the sides of the foredeck.

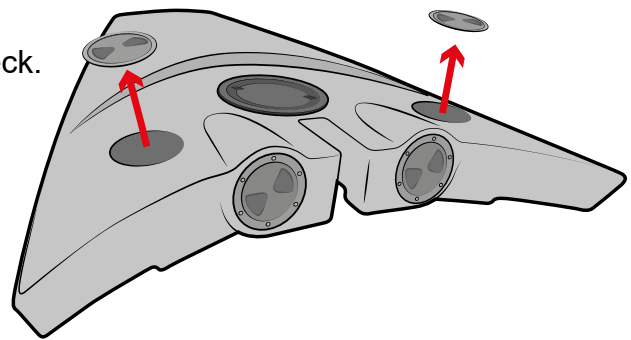

f)

At the base of the two compartments you will see a hole. Push down the rear of the foredeck so that these holes line up with the holes on the mast support beam.

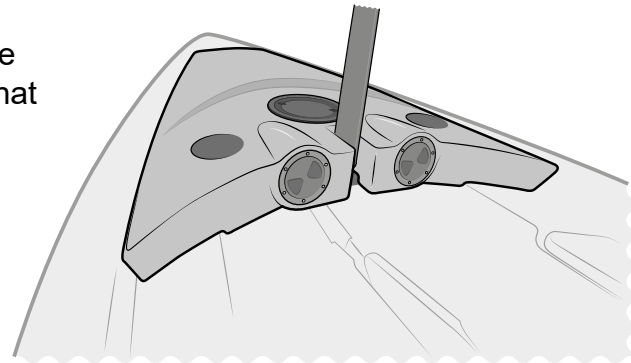

g)

Insert the two M8x50mm bolts through the washers provided into the holes in the beam and tighten.

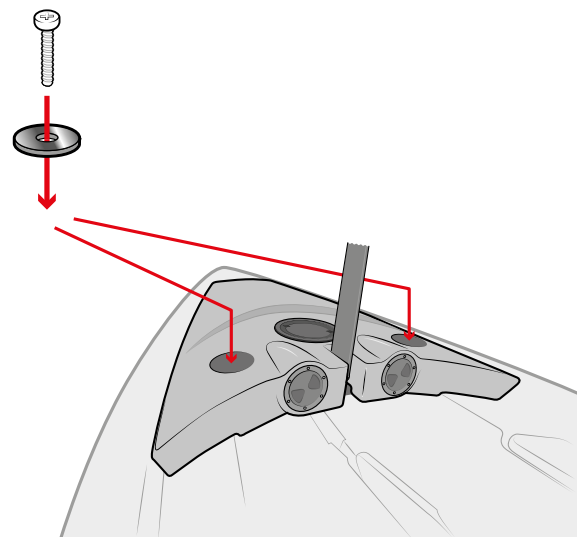

RS Quest 5.2 - Adjusting the trolley for extra foredeck weight

a)

Adding the foredeck will increase the weight of the Quest and will move the centre of gravity forward. To reduce the handling weight it is possible to adjust the front support of the trolley. Use a spanner to extend the front support. This will push the boat further back in the trolley and will aid maneuverability.

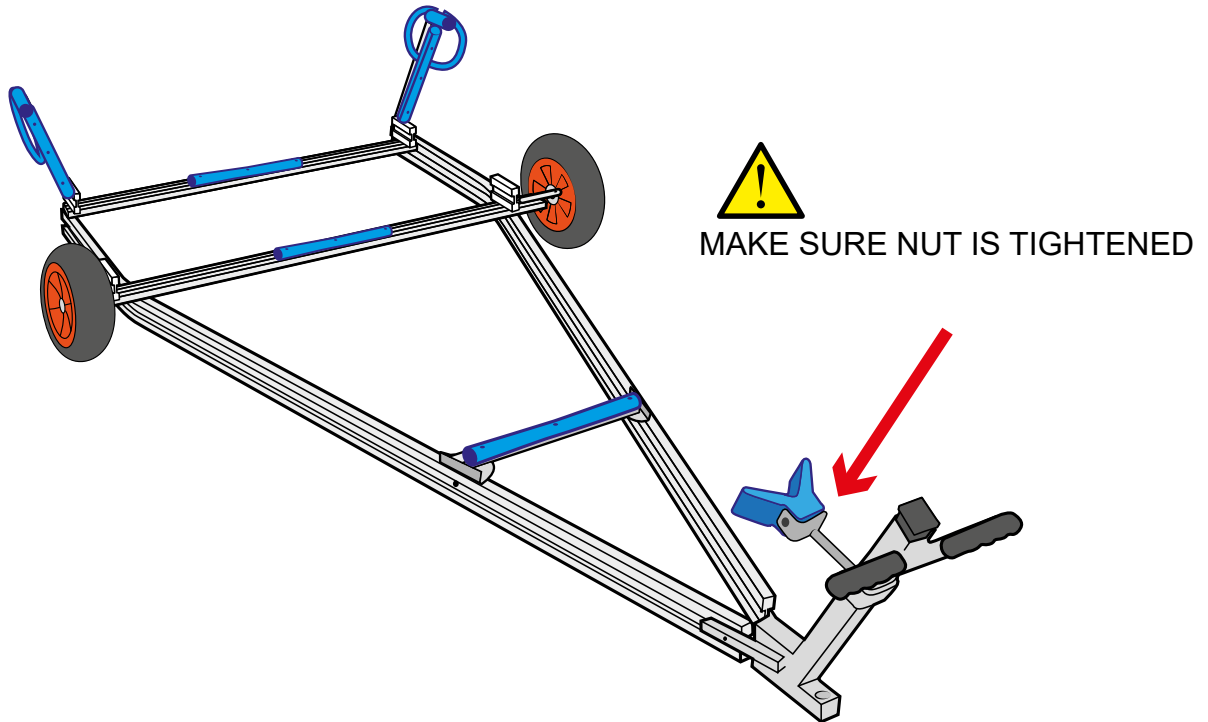

RS Quest

Rigging Guide

6 - Mast

To complete this section you will need:

- The mast and rigging packs
- A flat-bladed screw driver
- PVC electrical tape
- 8mm (or small adjustable) spanner



PLEASE FOLLOW RIGGING GUIDE IN CORRECT ORDER

RS Quest 6.1 - Joining the Mast Sections

The Quest mast comes in two sections which must be slotted together before stepping the mast.

Ensure that the sleeve and the inside of the tube are clean and free of sand. Quest rigs are designed with a tight engineering tolerance on the sleeve.

Ensure the tubes are aligned and push together. (The first part is often the hardest due to misalignment). If the tubes are hard to push together spray with MC-lube or a similar product.



RS Quest 6.2 - Fitting the Spreaders to the Mast

It is worth taking time to ensure that this section is completed correctly. Improperly fitted spreaders will result in undesirable sailing characteristics, and may even result in failure of the mast.

- Carefully unpack the spreaders from the top of the mast, being sure not to damage any of the securing split rings.
- The shrouds and forestay are in the rigging pack.

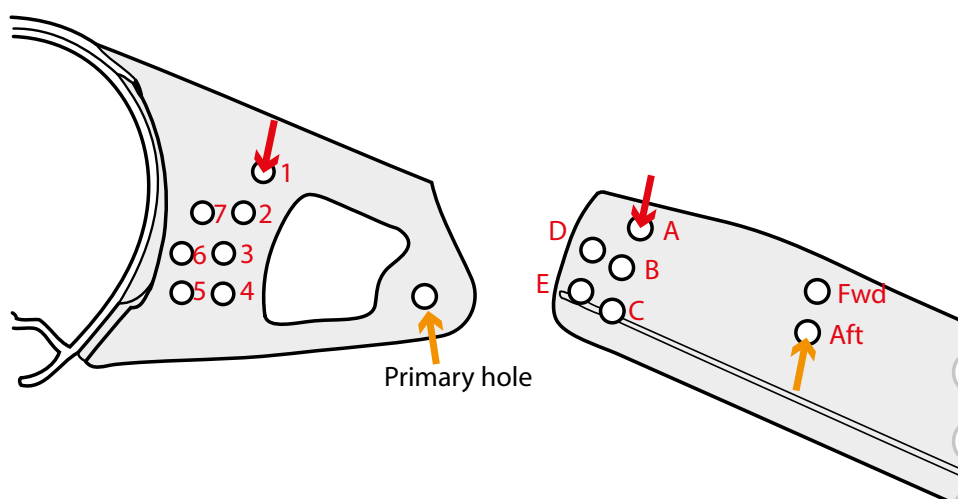

The Primary pin fits through the bracket's **primary hole** and through the **aft hole** in the spreader.

The Adjuster pin fits down through **hole 1** in the bracket and **hole A** in the spreader.



Tape up all the securing pins and rings to prevent them from being damaged, or from damaging the gennaker or spinnaker.

RS Quest 6.3 - Attaching the Shrouds to the Mast

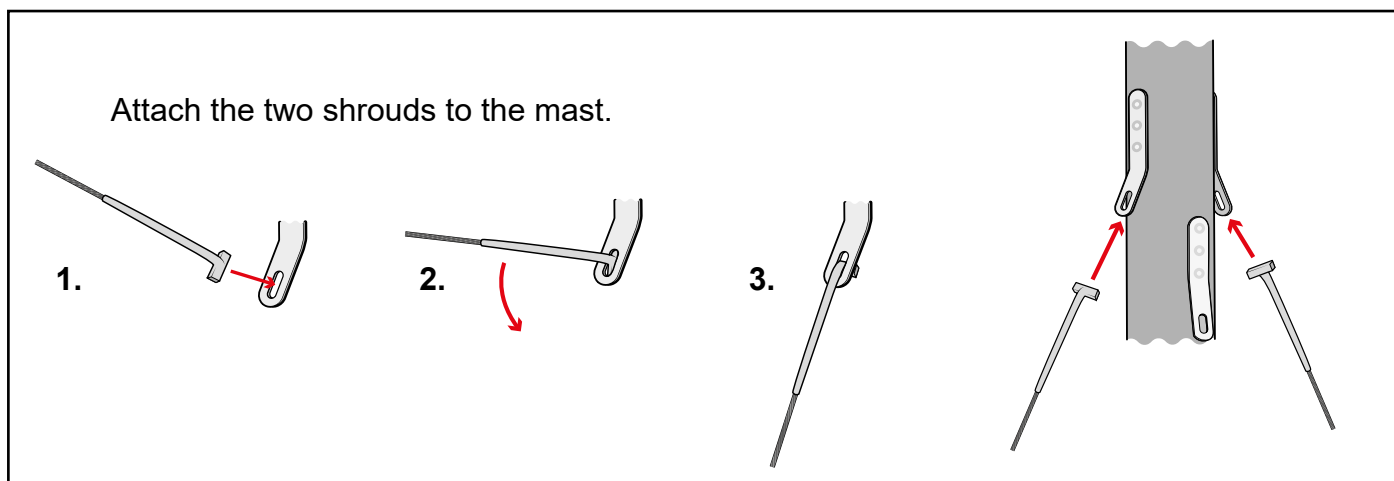

RS Quest 6.4 - Spreader ends

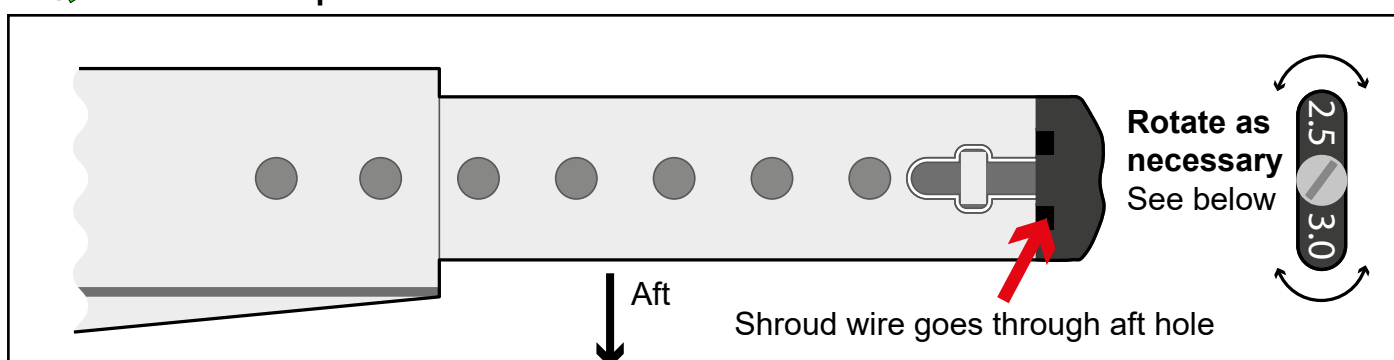

The spreader end cap incorporates two shroud wire slots to give a tight grip on either 2.5 or 3mm wire. The sizes are identified on the front face of the end cap (See diagram above). The RS Quest uses 3mm shroud wire so **the 3mm slot should be used.**

The end cap can also be rotated so that the shroud can be positioned at either the forward or aft position of the spreader end (see diagram above). **For the RS Quest the end cap should hold the shroud in the aft position.**

To attach the shroud, slacken the end screw, rotate the end clamp if necessary, then insert the shroud. Ensure that the shroud is tensioned between T-Terminal and spreader tip, then tighten the screw firmly. This method “locks in” the dihedral angle.

Length Adjustment:

The position is described by the number of adjustment holes visible. **For the RS Quest there should be 5 holes visible as shown in the diagram above.**



All clevis pins and bolts must be fitted with the flat head on top, and the pins must be locked with a split ring.



Tape all split rings, pins and the outboard end of the spreader extrusion.

This will reduce chafe on the mainsail and prevent flailing sails/halyards becoming damaged. Self-amalgamating tape is best, but PVC electrical tape is an adequate alternative.

RS Quest 6.5 - Main Halyard

a)

Feed one end of the main halyard into the track on the back of the mast through the opening above the gooseneck joint.

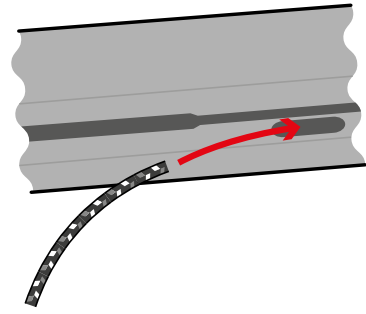

b) Feed the main halyard the whole way up the mast, through the masthead fitting, around the turning block and back down the mast.

Top tip: It is much easier to thread the halyard up the mast if you put a small screwdriver or needle in through the track and into the rope to pull the end upwards.

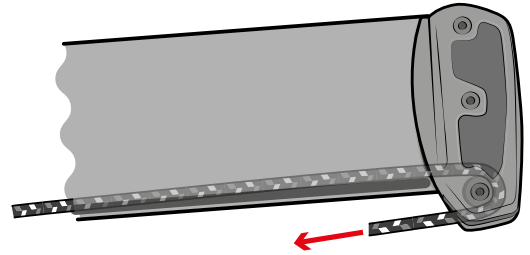

c) Add the plastic bobble on the end of the rope.



Tie off both ends of the main halyard at the bottom of the mast so that they are easily accessible once the mast is stepped in the boat.

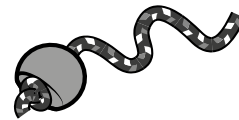

RS Quest 6.6 - Jib Halyard

a)

Shackle the 30mm block for the jib halyard to the second lowest eye on the front of the mast (below where the shrouds and forestay join the mast).

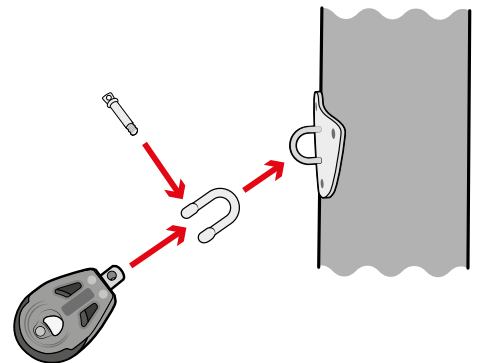

b)

Add the plastic bobble to one end of the jib halyard then pass the other end through the block and back down the mast.

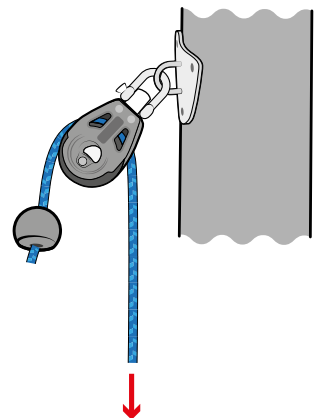

RS Quest 6.6 - Jib Halyard

c)

Pass one end of the jib halyard through the cleat on the port side of the mast above the gnáv bracket.

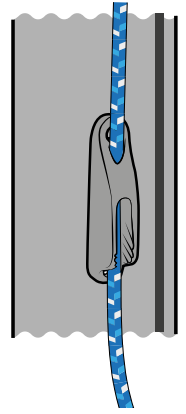

Tie off both ends of the jib halyard at the bottom of the mast so that they are easily accessible once the mast is stepped in the boat.

RS Quest 6.7 - Forestay

a)

Attach the top part of the forestay to the mast.

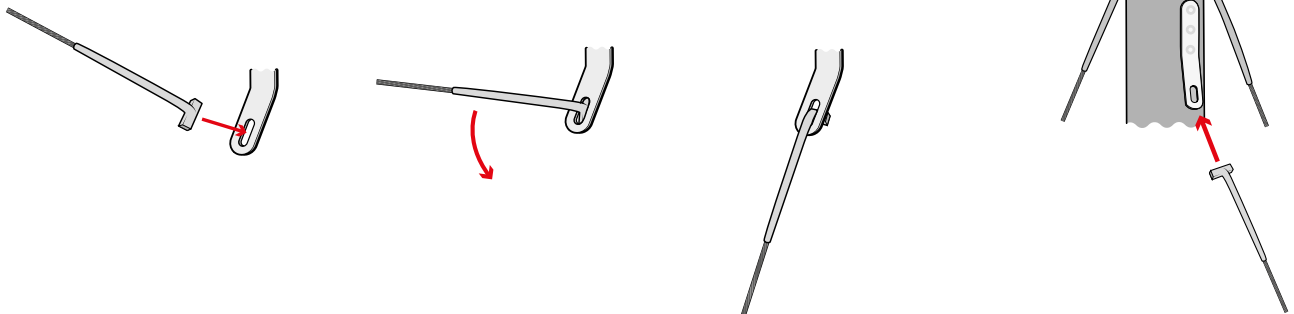

b)

Attach the lower part of the forestay to the jib furler joint using the clevis pin and split ring.



Add PVC tape around the clevis pin.

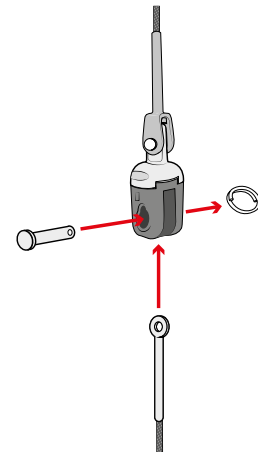

RS Quest 6.8 - Spinnaker Halyard Takeup Elastic

a)

Tie the metal ring to one end of the spinnaker halyard takeaway elastic found in the spinnaker pack using a knot-on-knot.



RS Quest 6.8 - Spinnaker Halyard Takeup Elastic

b)

Feed the other end of the spinnaker halyard takeaway elastic through the small ring on the front of the mast below the eyelet that the jib halyard block is attached to.

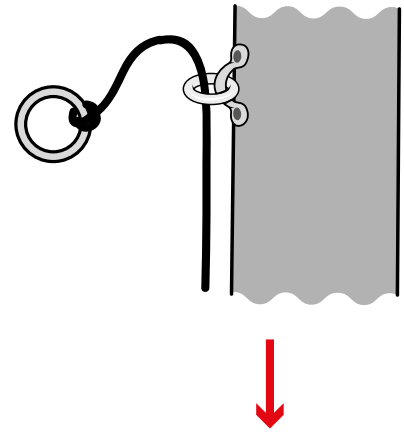

c)

Pass the end on the spinnaker halyard takeaway elastic down the mast, through the spinnaker pole eye on the front of the mast (if fitted) and tie it through the hole in the mast step heel.



Make sure the elastic is tight enough that the ring on the end of it is tight against the small ring on the mast.

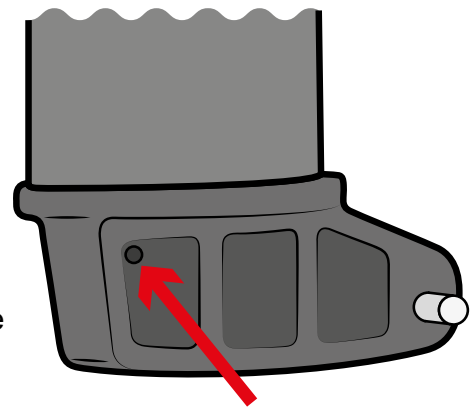

RS Quest 6.9 - Spinnaker Halyard Mast Turning Blocks

a)

Shackle the 30mm block for the spinnaker halyard to the eye closest to the mast head (just above where the shrouds and forestay join the mast).



Use pliers to tighten.

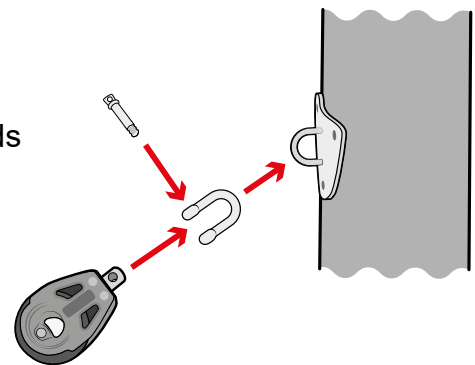

b)

Temporarily secure one end of the spinnaker halyard at the bottom of the mast. Once the mast is stepped in the boat this end will go to the front uphaul block.

Pass the other end of the spinnaker halyard up the mast, through the 30mm block and back down the mast.

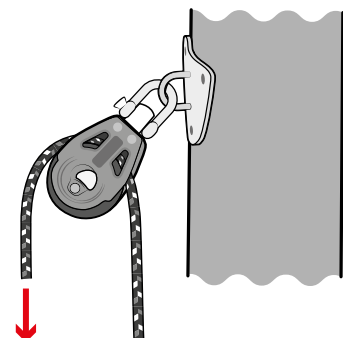

RS Quest 6.9 - Spinnaker Halyard Mast Turning Blocks

c)

Pass the end of the spinnaker halyard down the mast and through the metal ring on the end of the takeaway elastic.

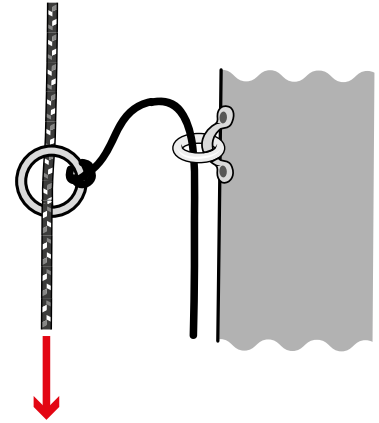

d)

Add the plastic bobble on the end.

When rigged, this end will attach to the head of the spinnaker.

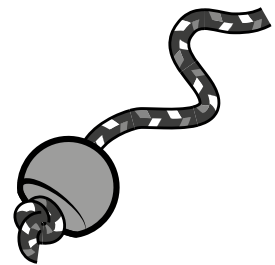

Temporarily tie off both ends of the spinnaker halyard at the bottom of the mast so that they are easily accessible once the mast is stepped in the boat.

If you wish to fit the optional trapeze kit you must do this before stepping the mast. See Section 12 for instructions.

RS Quest 6.10 - Attaching the Masthead Float (optional)

If you have purchased the optional masthead float, you will have to fit it before stepping the mast in the boat.

- a) Attach the bracket to the masthead float using the four bolts provided.

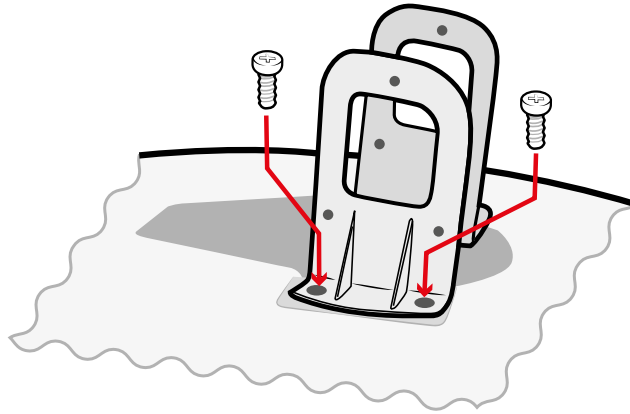

- b)

Slide the masthead float onto the mast with one plastic mounting plate on either side.

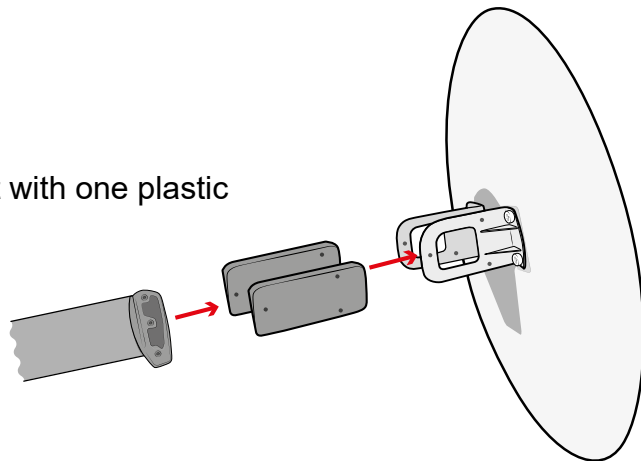

- c)

Make sure you have lined up the up the holes on the bracket, mounting plate and mast, then attach it using the 6 screws provided.

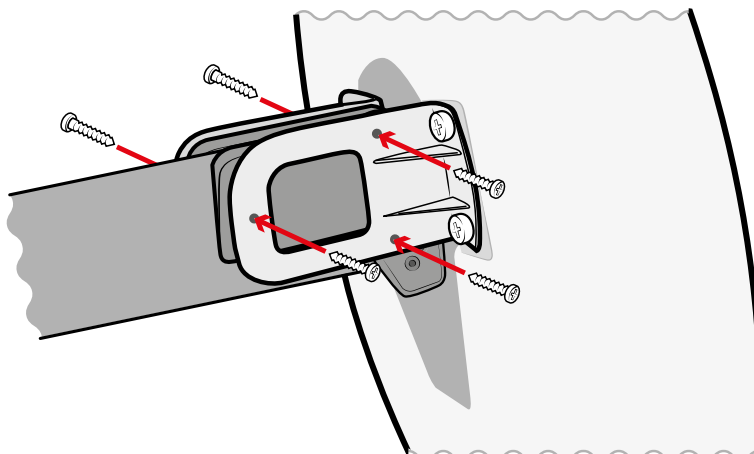



BEFORE PICKING UP THE MAST, CHECK THAT YOU ARE NOT IN THE VICINITY OF OVERHEAD POWER CABLES

- a) Before stepping the mast, familiarise yourself with how the “foot” (bottom end) of the mast will fit into the “step” (fitted to the boat).

Locate the mast foot in the mast step and lay the mast in the boat.

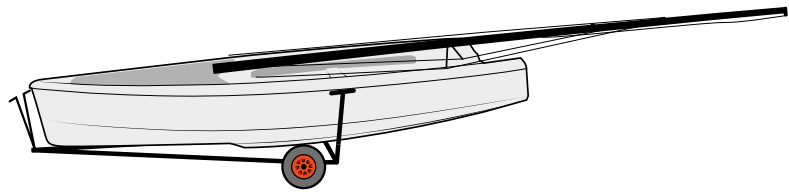
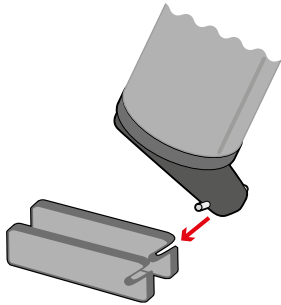

- b)

Slip the neoprene boot up the shroud, pointed end to the top.

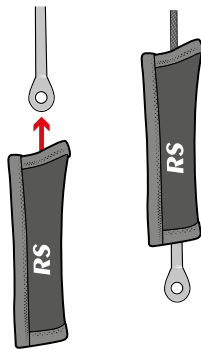

Note: On boats built from April 2017 onwards, neoprene vernier covers and 5mm bolts will be provided as standard.

For older boats, the Quest Upgrade Pack provides everything you need to bring your boat up to the newest spec.

- c)

If not already fitted, slide the adjuster plate onto the shroud eye bolt.

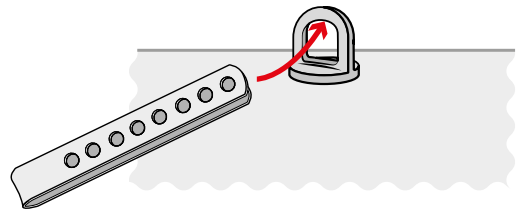

- d)

Attach the shroud to the middle of the shroud adjuster plate with the clevis pin and split ring provided.

In light winds use hole 2 or 3.

In strong winds use hole 4, 5 or 6.

Push the pin in from outboard towards the centreline of the boat.

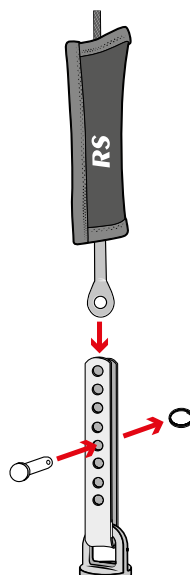

Wrap PVC electrician's tape around the split rings for security, and to avoid snagging. This is particularly important if you don't have the neoprene vernier covers.

RS Quest 6.11 - Shrouds**e)**

If using hole #4,5 or 6 use the M5 bolt and Nyloc in the top hole of the Vernier. Make sure the shroud passes outside the bolt.

If using hole 2 or 3 use of the bolt is not required

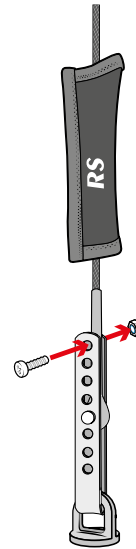

Ensure that the thread goes well into the nyloc of the nut, but do not bend the Vernier.

**f)**

Slide the boot down over the vernier.

**g)** Repeat **steps a-f** on the other side of the boat.

Ensure that the forestay is fitted correctly and loose at the lower end. Ensure all 3 halyards are tied to the pole ring on the front of the mast.



BEFORE STEPPING THE MAST, CHECK THAT YOU ARE NOT IN THE VICINITY OF OVERHEAD POWER CABLES

Now the mast is ready to be put up in the boat, or “stepped”.

REMEMBER

Check that both ends of the main halyard, jib halyard, and spinnaker halyard are tied off at the bottom end of the mast so that they are within easy reach when the mast is stepped.

Fig. 1

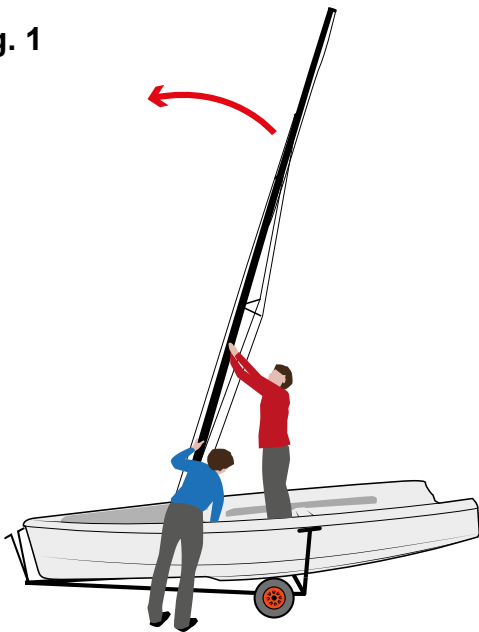
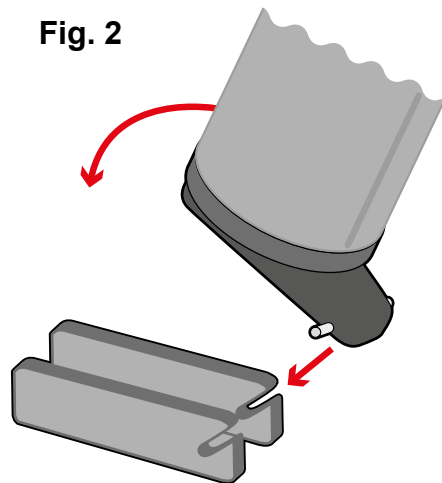

Fig. 2



Note: It is recommended that the mast should always be stepped with 2 people. If the wind is blowing, there will be a lot of pressure at the top of the mast making it wave around. Consider finding a second helper if you feel you will struggle!

RS Quest 6.12 - Stepping the Mast**a)**

Pass the mast, foot first, into the boat over the stern so that the foot lines up with the mast step. **See Fig.1**

b)

One person inside the boat should line the foot of the mast up correctly with the mast step so that the pins on either side slot into the grooves of the mast step. **See Fig. 2**

c)

You can now lift the mast with one person inside the boat and another helping from outside the boat until the mast is upright.



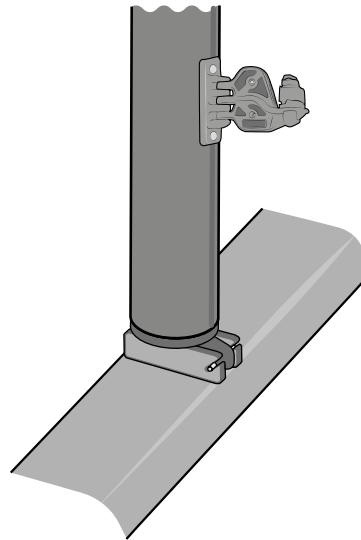

If the boat is in a trolley, do not walk aft of the balance point!

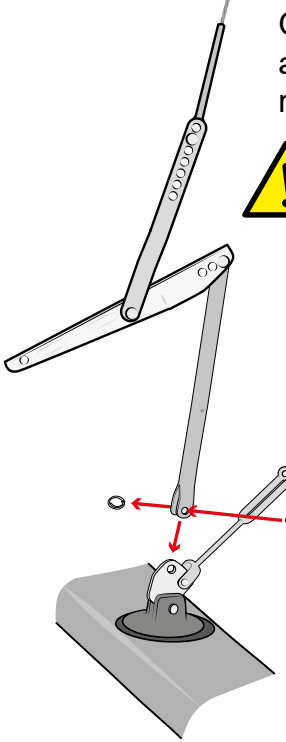

RS Quest 6.13 - Forestay



One person should continue to hold the mast upright while the other attaches the forestay to the foredeck eye with the clevis pin and split ring provided.

-  Ensure the tensioning lever points forwards.
-  Release when not in use.
-  PVC tape around the ring to prevent it catching on the sails.

Note: Boats built from April 2017 onwards will have a hook to attach the jib tack rather than a shackle. See the Quest Upgrade Pack for details of how to change your boat to the new spec.

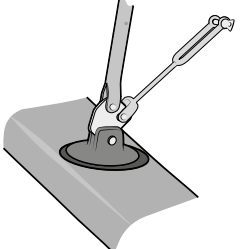

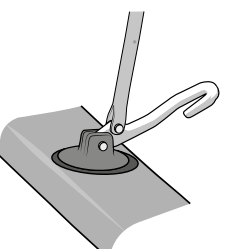

pre April 2017



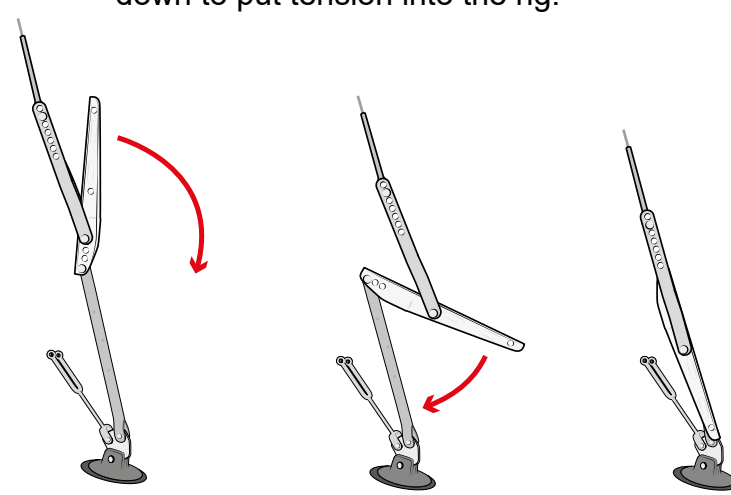

post April 2017

RS Quest 6.14 - Rig Tensioning

Once the shrouds are attached, pull the lever on the forestay the whole way down to put tension into the rig.

-  This needs to be hard to do. If it feels loose adjust the shrouds accordingly.
-  Mind your fingers.
-  Release when not in use.

RS Quest

Rigging Guide

7 - Boom



PLEASE FOLLOW RIGGING GUIDE IN CORRECT ORDER

RS Quest

RS Quest 7.1 - Fitting the boom

To complete this section, you will need:

- The boom
- The gnav bar

a)

Connect the gnav bar to the slider at the front end of the boom.

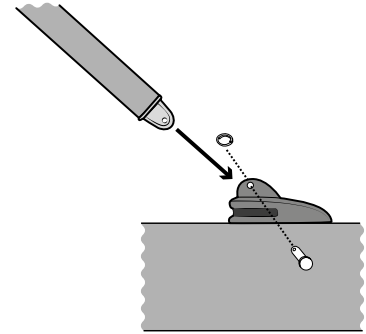

b)

Open the drop nose pin then connect the front of the boom to the gooseneck on the mast.

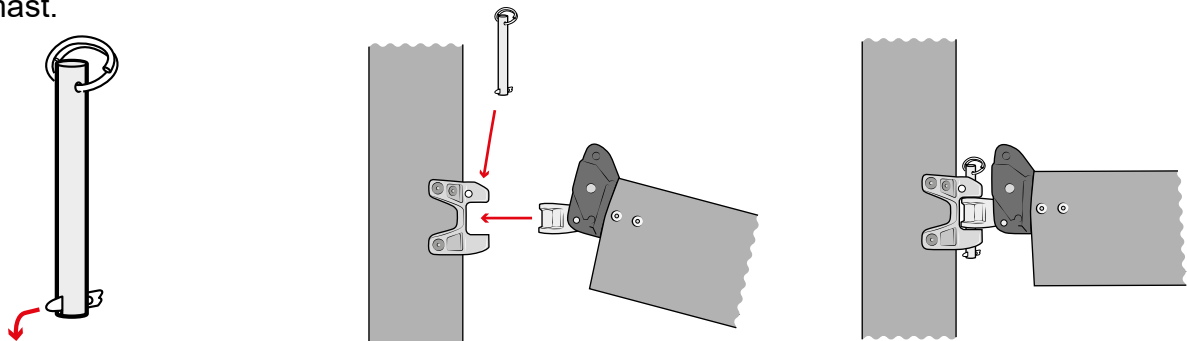

c)

Connect the upper end of the gnav bar to the bracket on the mast above the gooseneck.

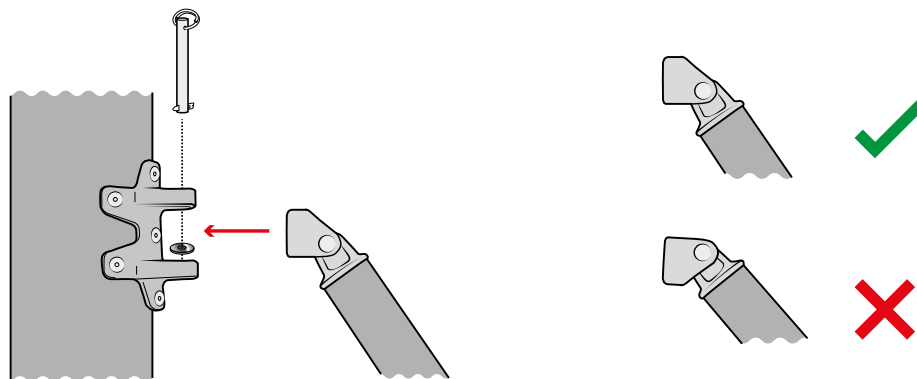

It is vital that the gnav toggle is inserted as shown above. Failure to do so will result in damage to the strut assembly.

RS Quest 7.2 - Gnav control line

Feed the gnav control line down through the swivel block and through the cleat below the boom. Tie a stopper knot in the end of the rope

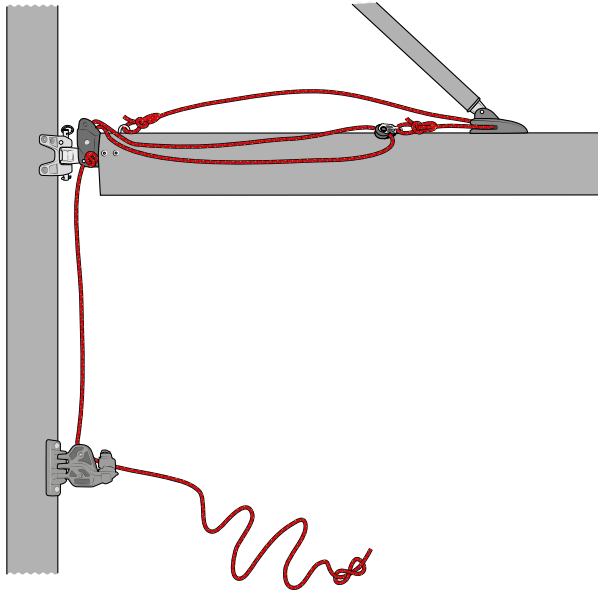
**TOP TIP**

You can keep the boom up by hoisting with the mainsheet at the rear of the boom.

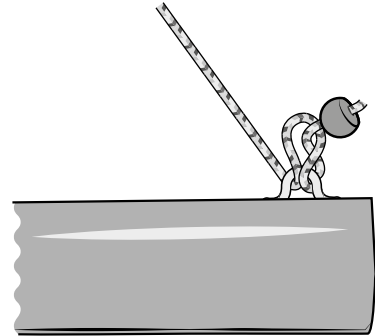

RS Quest 7.3 - Rigging The Mainsheet

a) Rigging the Mainsheet Strop

Find the 40mm block with a becket and the mainsheet strop from the rope pack.

Take the mainsheet strop and fold it in half to form a loop.

Pass this loop through the base of the block.



b)

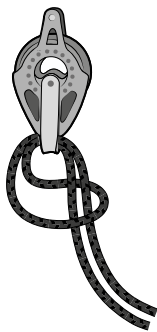

Pass the two tails of the rope back through the loop, making sure the block is in the middle.

c)

Pass each tail of the rope through the plastic fittings on the aft side of the thwart and tie a stopper knot.

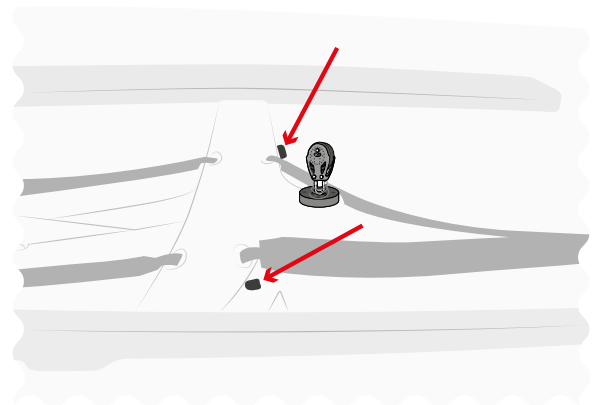

RS Quest 7.3 - Rigging The Mainsheet

d)

Tie one end of the mainsheet to the becket on the mainsheet block (with a bowline) then thread through the blocks as shown.

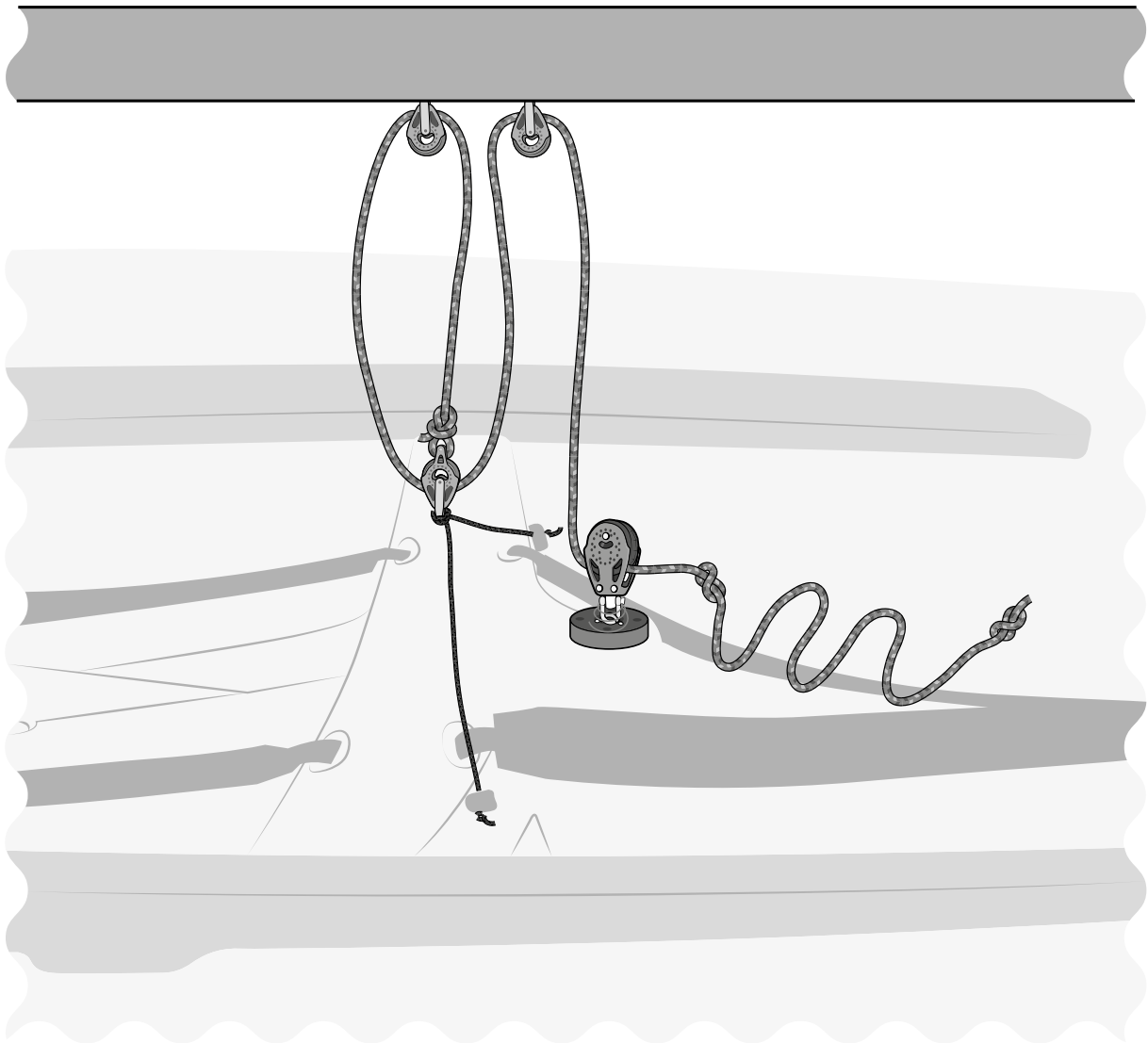

Tie a second knot in the mainsheet to prevent the boom from hitting the shrouds.

e)

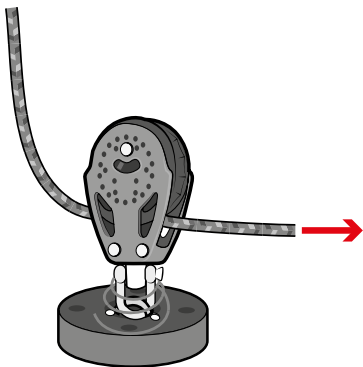

Pass the end of the mainsheet through block 4 (ratchet block).

Make sure you feed the rope through the correct way (as indicated by an arrow on the ratchet block).



Ratchet can be turned on and off with this switch.

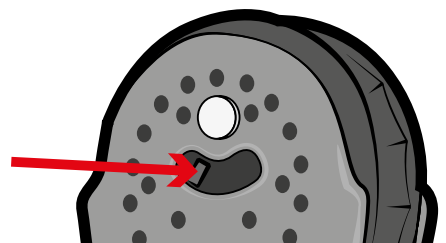

RS Quest

Rigging Guide

8 - Mainsail and Jib



PLEASE FOLLOW RIGGING GUIDE IN CORRECT ORDER

RS Quest

RS Quest 8.1 Preparing the Sails.

a)

Sail numbers should be supplied with each sail.



Cut along dotted lines to form the correct sail numbers.

b)

Unroll your new sail. Stick the sail numbers on sail by following the measurements below.



NUMBERS MUST BE PLACED HIGHER ON THE STARBOARD SIDE.

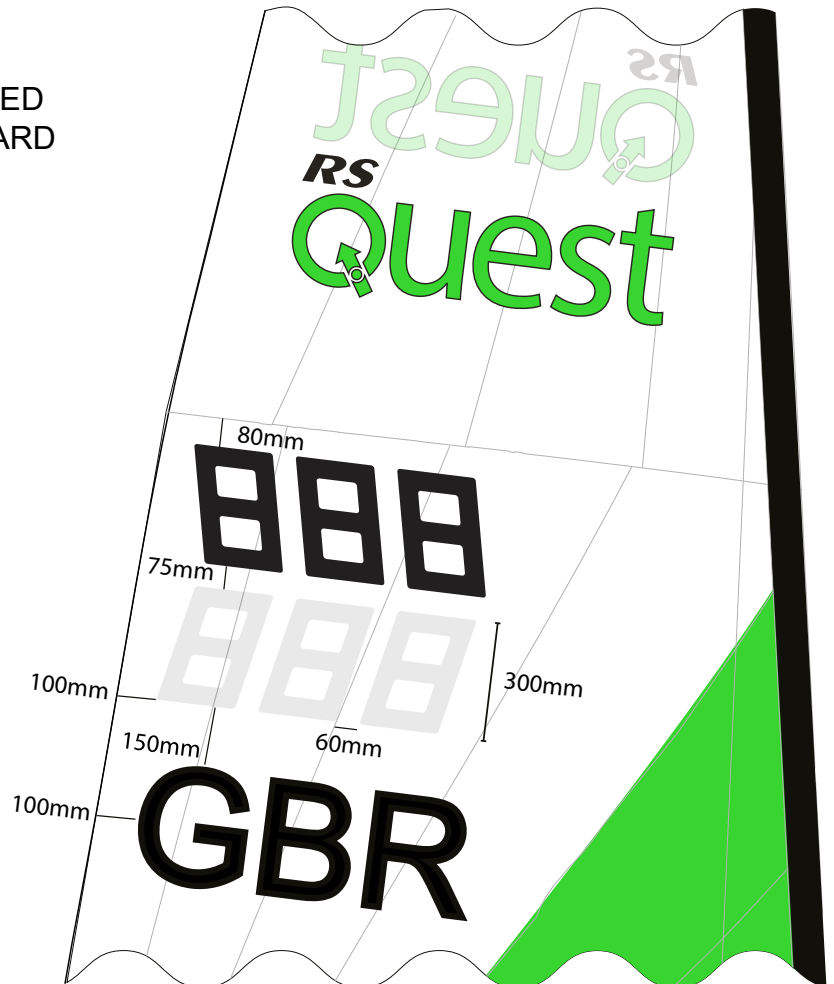

RS Quest 8.1 Preparing the Sails.

- c) There are also faint lines on the sail to show where to place the national letters (although these are optional and not supplied as standard.)



RS Quest 8.2 Battens

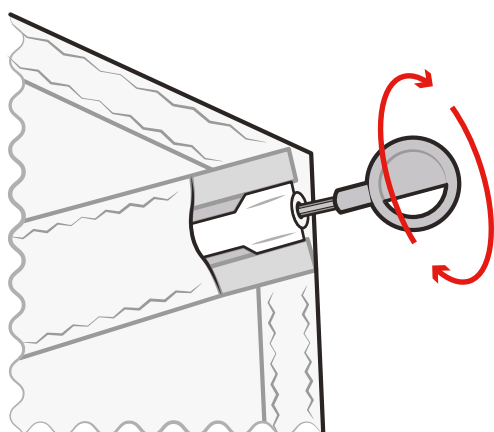

- Batten key should be on clew of sail.

Check the inboard ends of the battens are positively located in the inboard plastic end fitting. To tension, turn the key clockwise until the cloth becomes just tight. If it is over tightened you will have trouble tacking the head of the sail in light weather. Insufficient tension and the sail will set up too flat with wrinkles running down from the head.

RS Quest 8.3 Sail Care

Wash salt off sails after use and dry. Roll from the head. It is easier to fold the head in (as shown) so the top of the battens coincide before starting rolling. Store sail in its bag in dry conditions away from sunlight. Although the sail is made from a quality high denier fabric it is best to slightly slacken the top 2 battens' tension for long term storage.

When using a new sail for the first time, try to avoid extreme conditions as high loads on new sailcloth can diminish the racing life of the sail.

If your sail is stained in any way, try to remove it using a light detergent and warm water. DO NOT attempt to launder the sail yourself. A sail can be temporarily repaired using a self-adhesive cloth tape, such as Dacron or Mylar. The sail should be returned to a sail maker for a professional repair. Check for wear and tear, especially around the batten pockets, on a regular basis.



Roll from 2nd Batten.

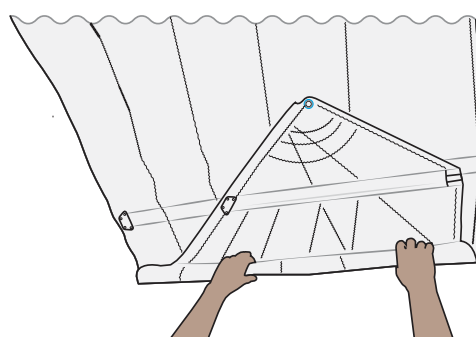

RS Quest 8.4 - Hoisting The Jib

To complete this section, you will require:

- The jib
- The jib sheets
- The top furling unit as attached to the jib halliard

a)

The furling line emerges from under the beam through the cleat underneath the Port side.

Ensure that the furling unit is fully charged so that all the furling line is wound round the unit (turn anticlockwise) and very little left at the cleat.

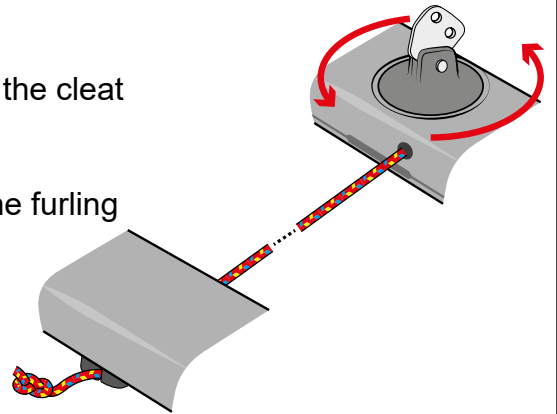

b)

Attach the end of the jib halyard with the plastic stopper on it to both rope loops on the jib head unit using an overhand knot.

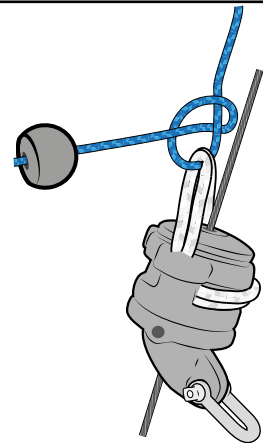

c)

Unroll the jib and connect the head of the sail to the top furling unit using the shackle.

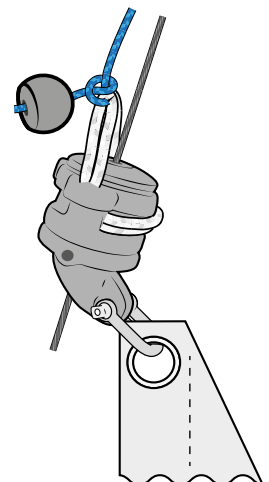
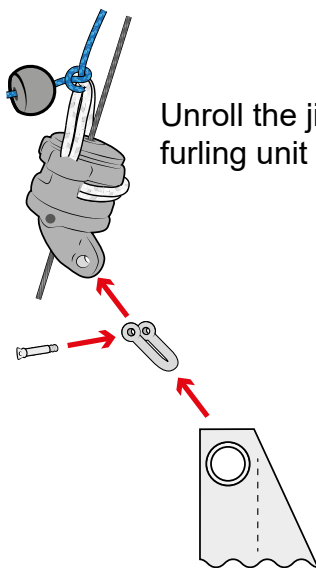

Note: Boats built from April 2017 onwards will have a new style of jib shackle. The RS Quest Upgrade Pack contains the new shackle and everything else needed to bring older boats up to current spec.



d) Attach the tack of the jib to the furler unit.

Boats built April 2017 onwards or older boats with the upgrade pack fitted:

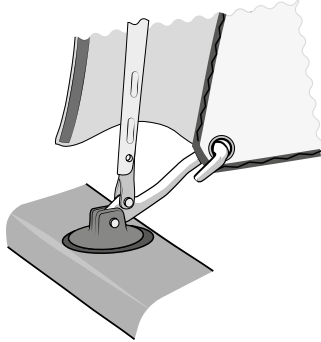

Hook the jib onto the furler unit.

Boats built before April 2017

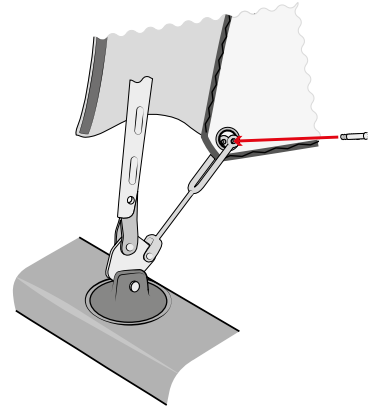

Fit the shackle on the furler unit through the cringle on the tack of the jib. Use pliers to tighten.

e)

Hank the jib onto the forestay.

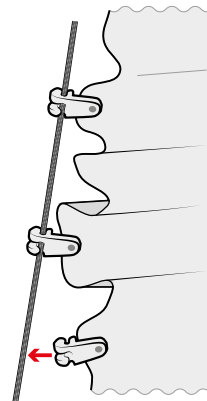

g)

Hoist the jib by pulling on the jib halyard, then cleat it off.

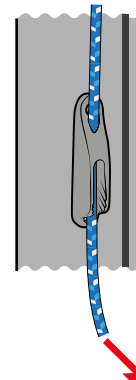

f)

Find the middle of the jib sheet, fold it back on itself, such that the two ends are together. Grab the folded mid point and pass it through the cringle in the jib clew, and then pass the two loose ends through that loop and pull tight. The result should look like this.

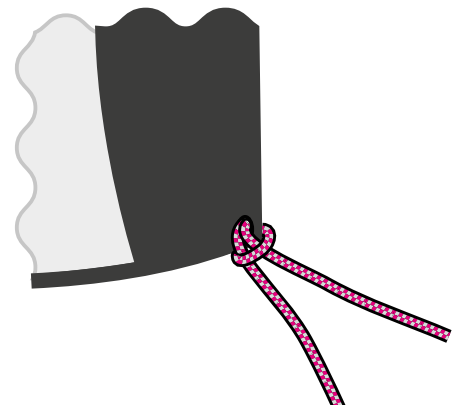

RS Quest 8.4 - Hoisting The Jib

- g) Lead one end of the jib sheet along the side of the boat and then down to the jib fairlead and cleat. Thread it through the fairlead and through the jib cleat. Repeat with the other end of the jib sheet, making sure they pass either side of the mast. You can either tie a figure-of-eight knot in each sheet, or tie the two ends together. Preferably tie together.

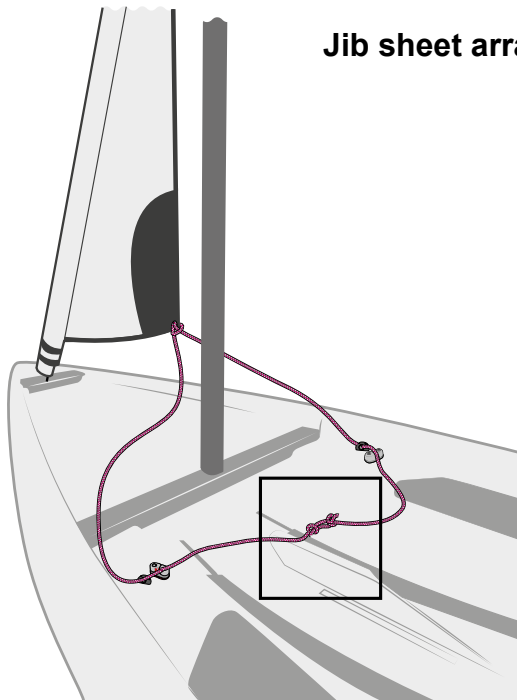

Jib sheet arrangement

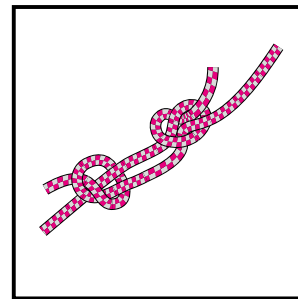

h)

Furling and unfurling the jib is best done from the front of the cockpit, or standing on the Port side of the boat adjacent to the shroud - in both cases with good access to the furling cleat.

To furl the jib, hold a little tension on the jib sheet and then firmly pull the furling line from the cleat. To unfurl, it is the reverse – pull the sheet and ease the furling line through the cleat.

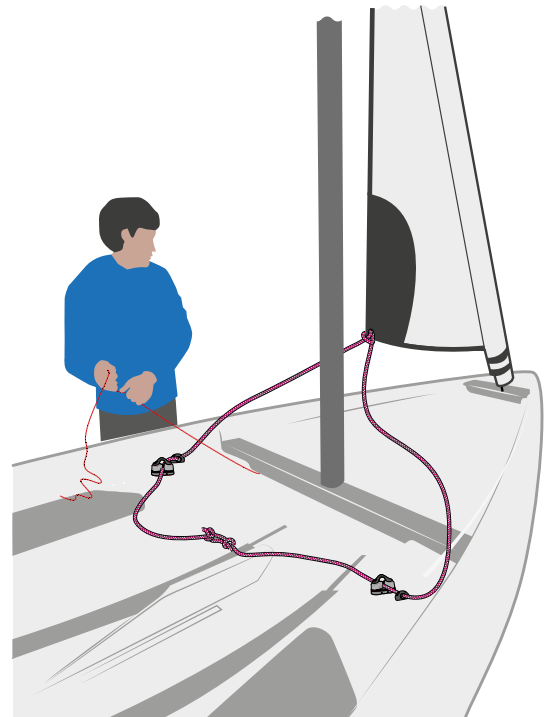

NB. Furling the jib – take care the spinnaker halyard does not get caught at the top of the jib furler – pull it in towards the mast to keep it clear of the top of the jib.

RS Quest 8.5 - Outhaul

a)

Slide the mainsail clew slug into the track on the top of the boom.

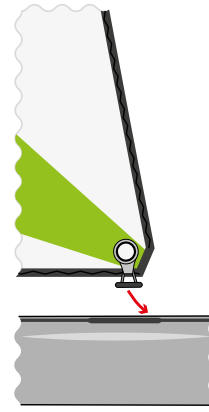

b)

Attach one end of the outhaul line to the eye on the end of the boom (on top) with a knot-on-knot.

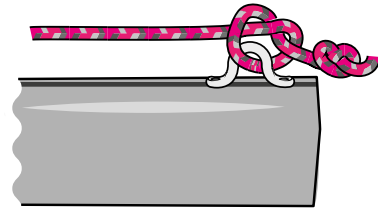

c)

Pass the other end of the outhaul line through the cringle on the clew of the mainsail.



d)

Pass the end of the outhaul back through the eye on the end of the boom.

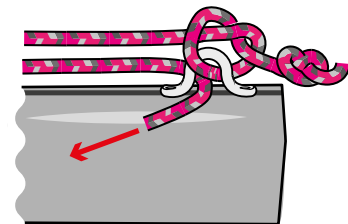

e)

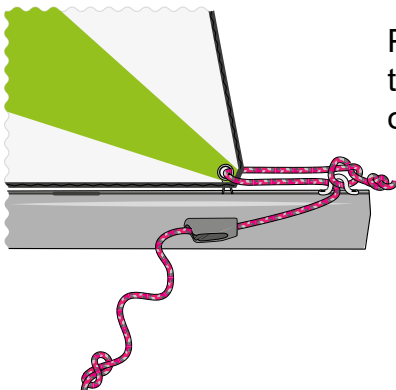

Pass the end of the outhaul back along the boom and through the cleat (on the Port side of the boom) as shown. Tie a figure of eight knot in the tail.

Do not tension until the mainsheet is hoisted.

Release when the mainsail is dropped.

RS Quest 8.6 - Hoisting the Mainsail

To hoist the mainsail:



Put the boat head to wind.

a) Unroll the mainsail.

b) Take the end of the main halyard that emerges from the top of the mast, and tie it to the head of the mainsail, using a knot-on-knot.

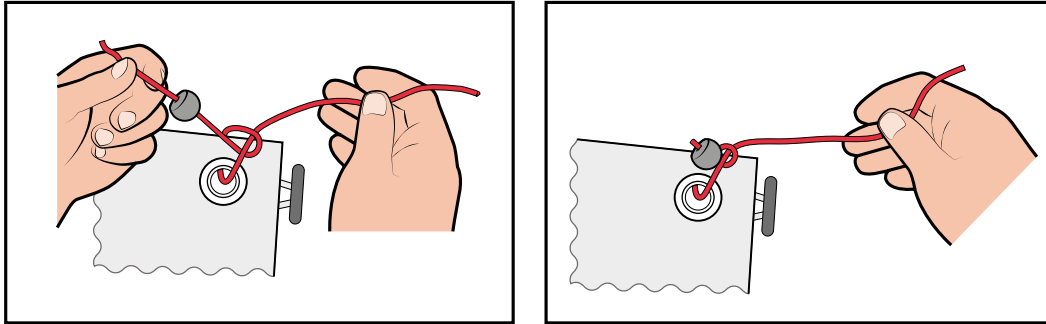

Tying the main halyard

c)

Put the top of the main sail into the opening in the mast track, just above the gooseneck mast collar, from the starboard side of the boat.

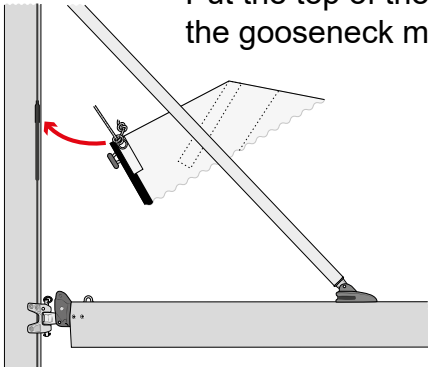

d)

Holding the main sail in line with the mast, pull on the end of the main halyard. Pull the main sail up to the top of the mast. You will need to keep the sail in line with the mast to make pulling it up easier, especially when passing the batten pockets.

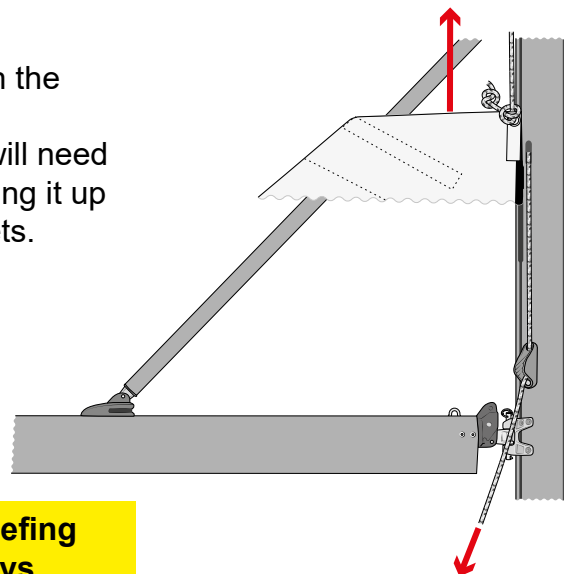

If you are hoisting full sail ensure that the luff reefing slug, used for and adjacent to the reef point, stays OUT of the mast track.

RS Quest 8.6 - Hoisting the Mainsail

e)

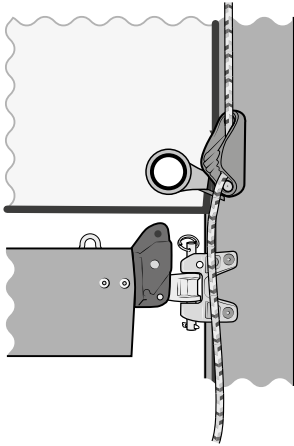

When the sail reaches the top of the mast, cleat off the main halyard in the upper cleat on the Starboard side of the mast.

Tie a figure-of-eight knot in the tail.

f)

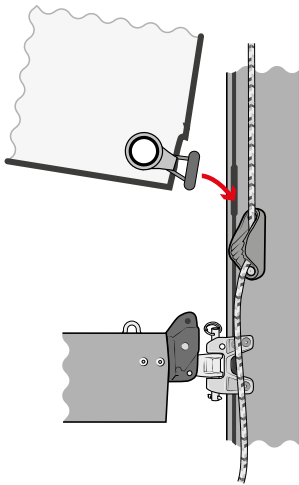

Insert the slug on the tack of the mainsail into the track on the mast and pull the tack of the sail down towards the boom.

g)

The main halyard tail can now be tidied away into the pouch on the sail. There are two pouches on the sail for the main halyard. Use the lower one unless the mainsail is reefed.

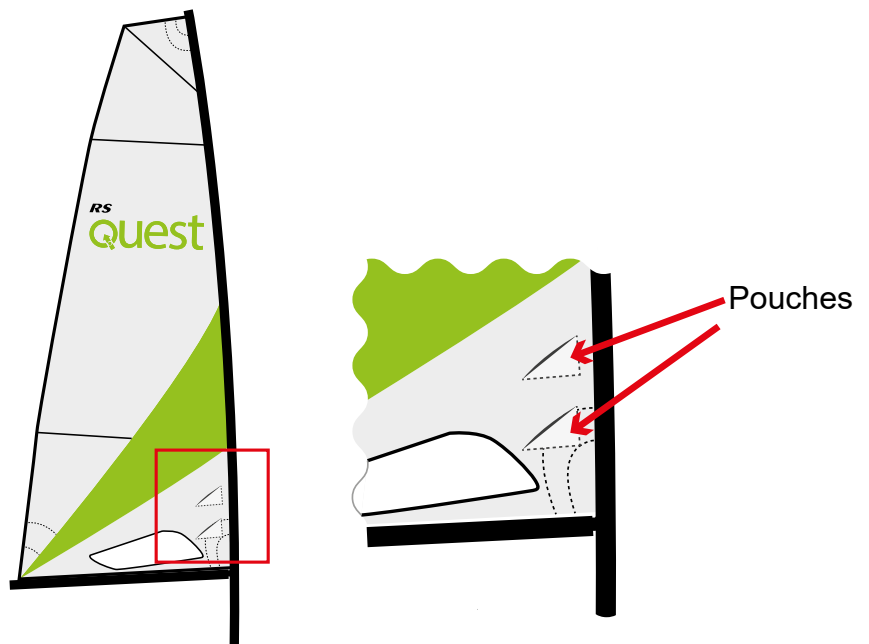

RS Quest 8.7 - Downhaul

a)

Tie an overhand knot in one end of the downhaul rope.

Thread the other end through the hole in the boom gooseneck joint.

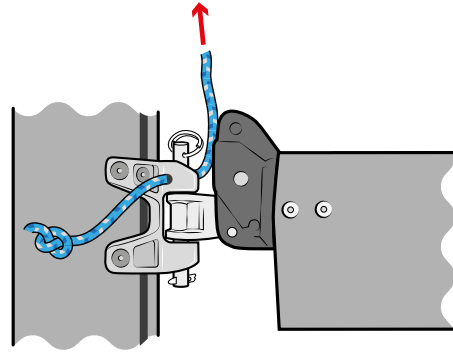

b)

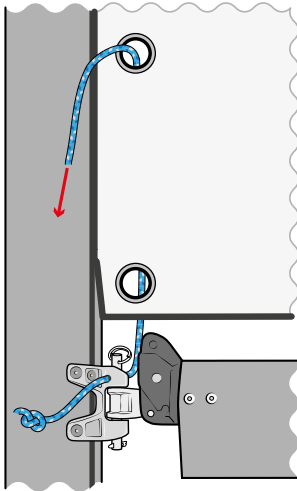

Pass the end of the downhaul through the second cringle on the luff of the mainsail, then down through the lower cleat on the port side of the mast.

Tie a figure-of-eight knot in the end.

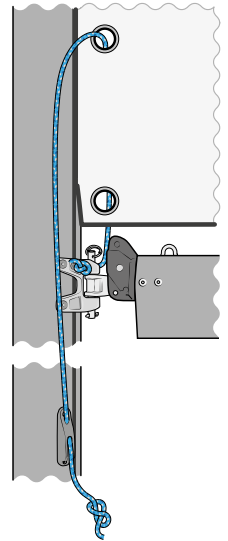

RS Quest 8.8 - Mainsail tack strap

From April 2017, new boats will be provided with a mainsail tack strap as standard. For older boats, the RS Quest Upgrade Pack will provide you with everything you need to bring your boat up to the newest spec.

This strap helps to keep the tack of the mainsail in place.

a)

Put the strap through the tack eye of the mainsail, then strap it onto the mast.

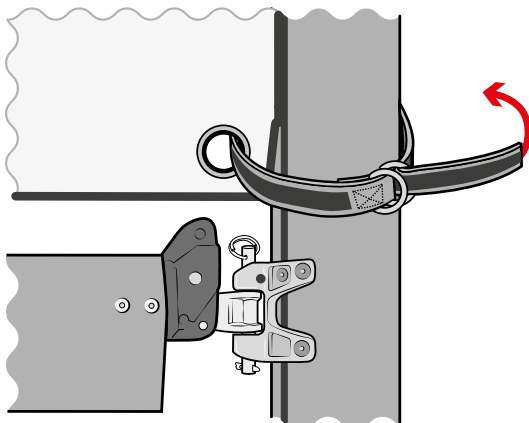

Make sure the main halyard goes under the strap to prevent it from uncleating the halyard.



The spinnaker and jib halyard need to go over the strap to minimise friction.

RS Quest

Rigging Guide

9 - Gennaker/Spinnaker



PLEASE FOLLOW RIGGING GUIDE IN CORRECT ORDER

RS Quest

RS Quest 9.1 - Rigging the Asymmetric Spinnaker

a)

Before stepping the mast you should have attached the spinnaker halyard block to the mast and threaded the spinnaker halyard through it. You should now have two ends of the spinnaker halyard at deck level.

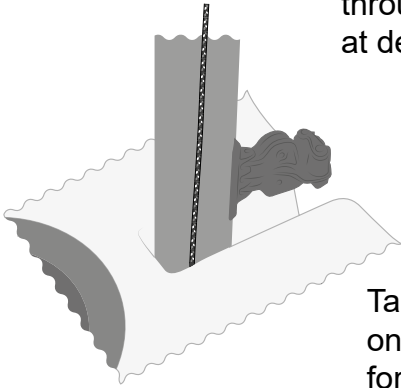

Take the end of the spinnaker halyard without the plastic bobble on it and feed it down the port side of the mast and through the foredeck (if attached) past the mast step.

b)

Pass the spinnaker halyard through the 30mm block to the port side of the bowsprit channel, and forward towards the bow (passing below the spinnaker sock).

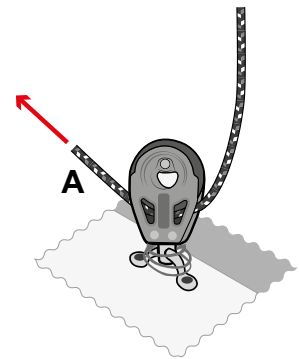
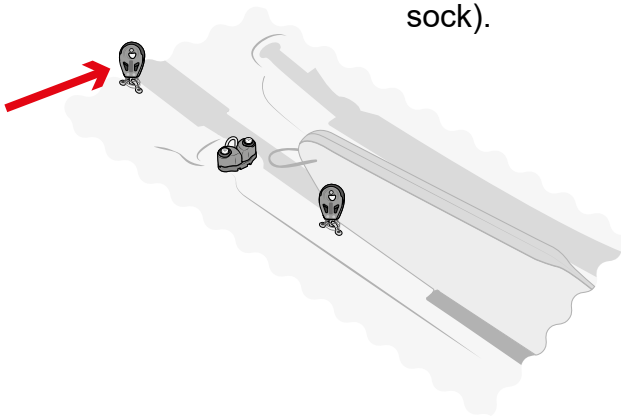

c) Pass the end of the spinnaker halyard through the 30mm block at the bow as shown.

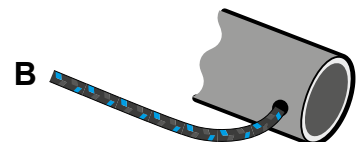
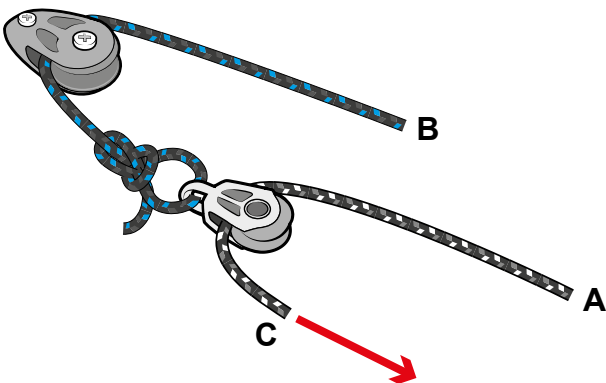

RS QUEST 9.1 - Rigging the Asymmetric Spinnaker

d)

Feed the end of the spinnaker halyard back towards the cockpit (again passing underneath the spinnaker sock). Pass it through the cleat and then the block just to the port side of the centreboard case.

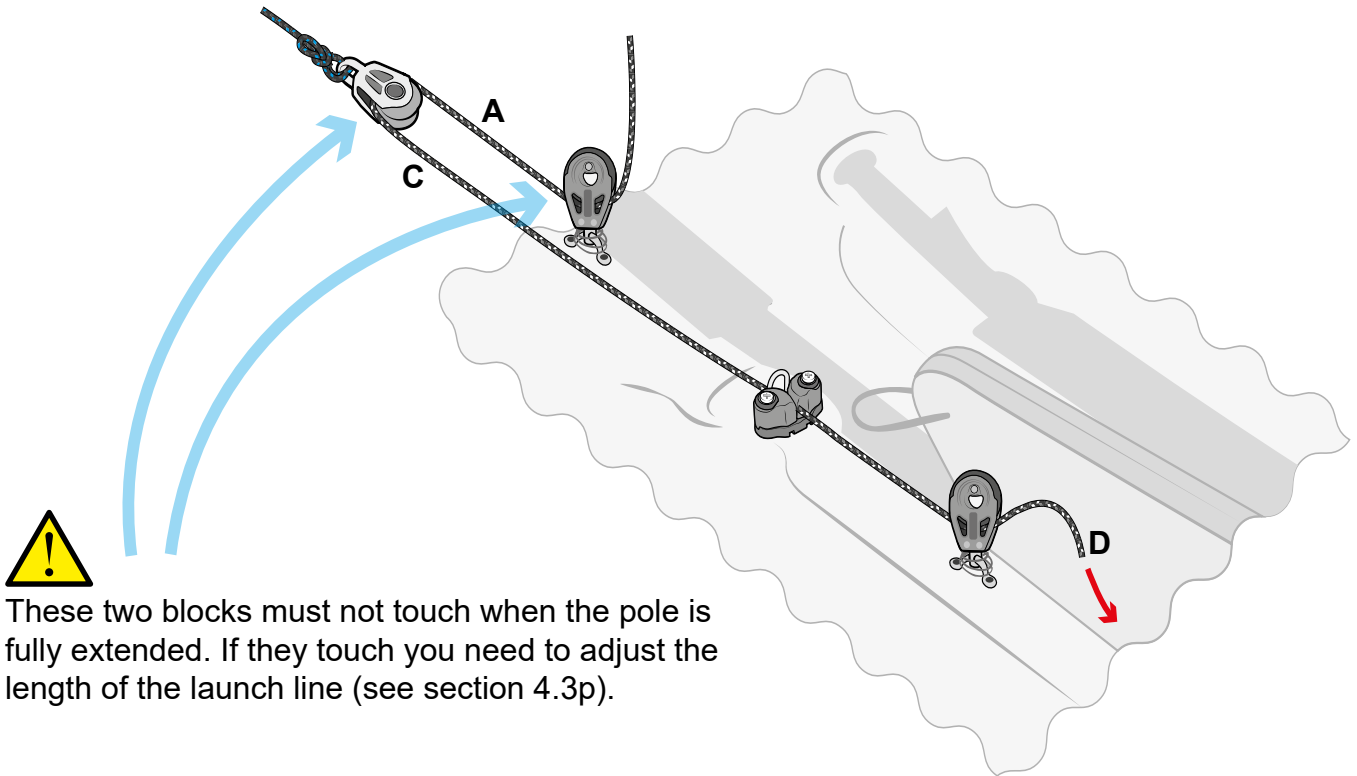

These two blocks must not touch when the pole is fully extended. If they touch you need to adjust the length of the launch line (see section 4.3p).

e)

Pass the spinnaker halyard through the block at the aft end of the spinnaker sock and then through the spinnaker sock towards the bow.

You may need to use the tiller extension as an aid to threading the halyard up the spinnaker sock.

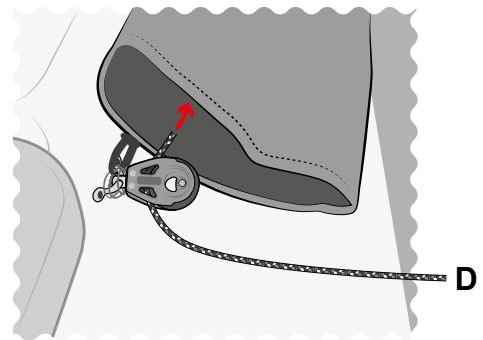

f)

Bring the tail of the spinnaker halyard out through the mouth of the spinnaker sock and pass it through the metal rings on the spinnaker before tying it to the rope eyelet on the back of the spinnaker with a bowline.

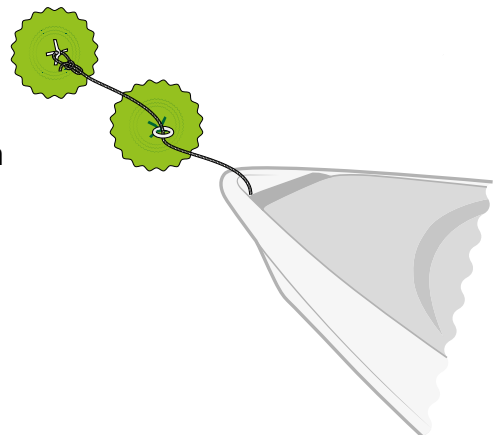

RS Quest 9.1 - Rigging the Asymmetric Spinnaker

g)

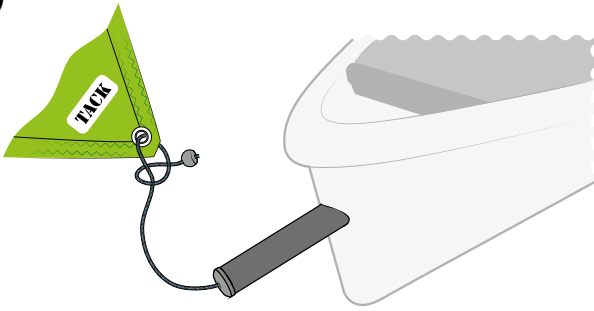

Attach the tack of the spinnaker to the line coming from the end of bowsprit.

h)

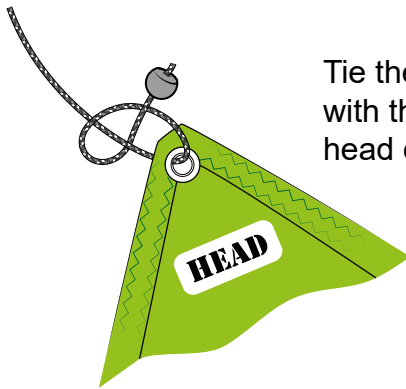

Tie the end of the spinnaker halyard with the plastic bobble on it to the head of the spinnaker.

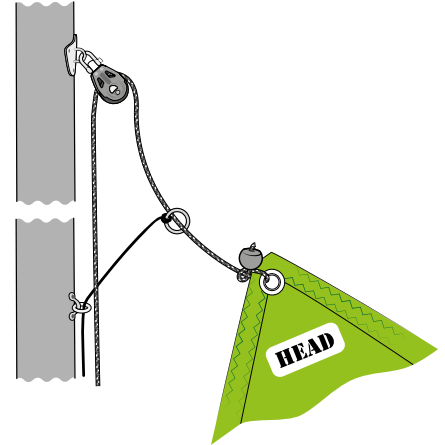

Asymmetric Spinnaker System

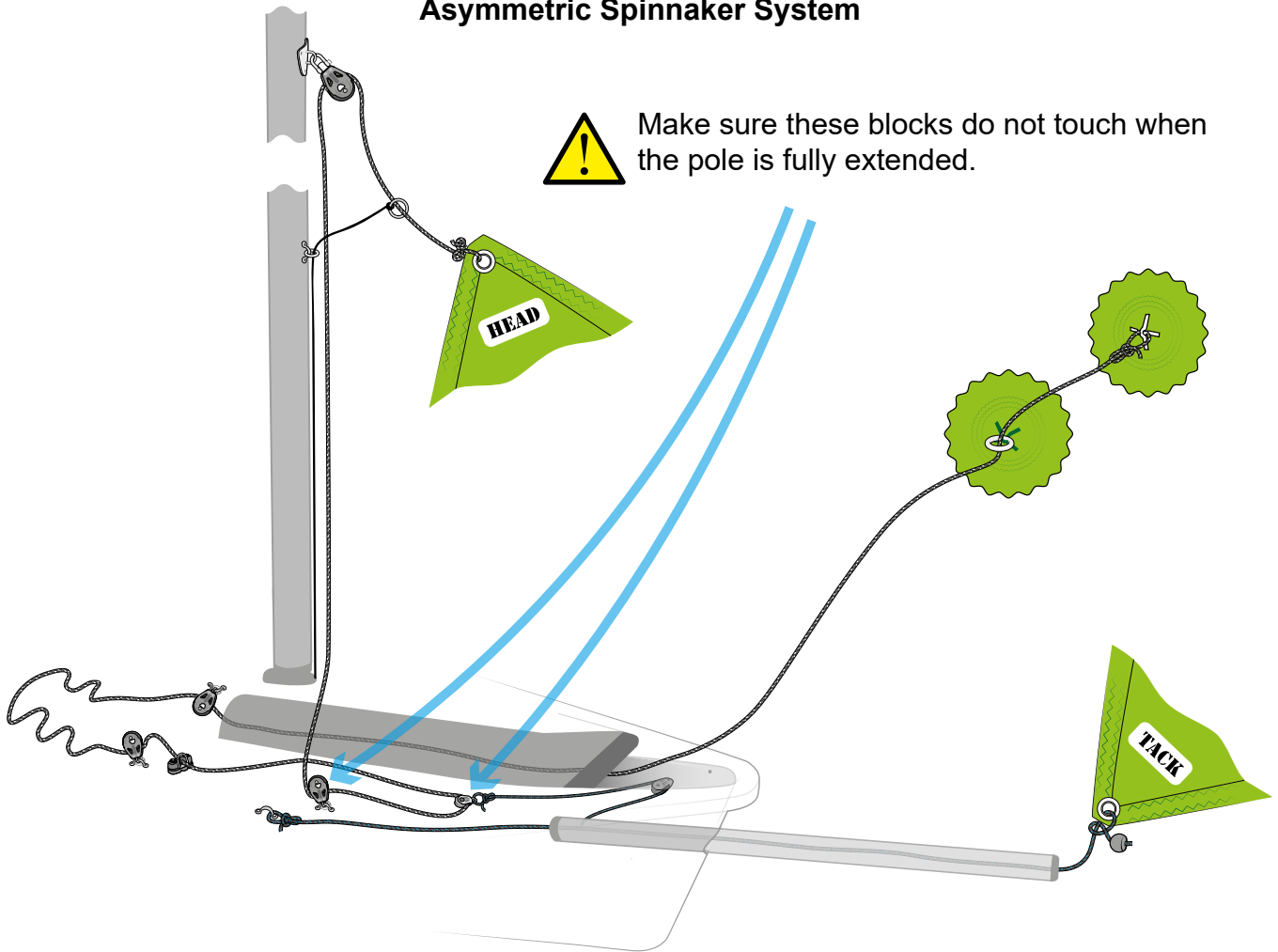

Make sure these blocks do not touch when the pole is fully extended.

RS Quest 9.1 - Rigging the Asymmetric Spinnaker

i)

Shackle the two ratchet blocks from the asymmetric spinnaker pack to the shroud eye bolts on either side of the boat. The shackle should be attached forward of where the shroud adjuster attaches.

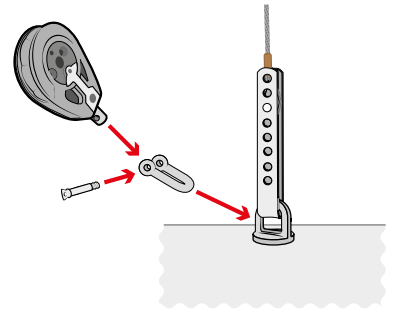

j) Find the middle of the gennaker sheet and double it over to form a loop.

Pass this loop through the eyelet at the clew of the gennaker.

Pass the rest of the sheet through the loop and pull it tight. This is the same arrangement as the jib sheet, so you will have done it before.

k)

With the gennaker on the port side, thread one end of the gennaker sheet through the block by the port shroud adjuster plate, in the direction of the arrow on the block .

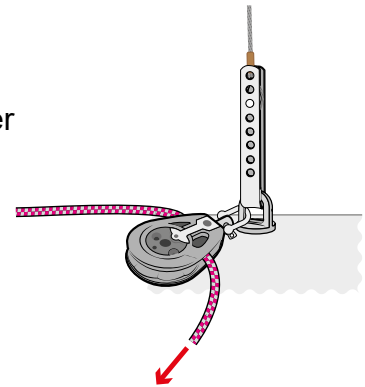

l)

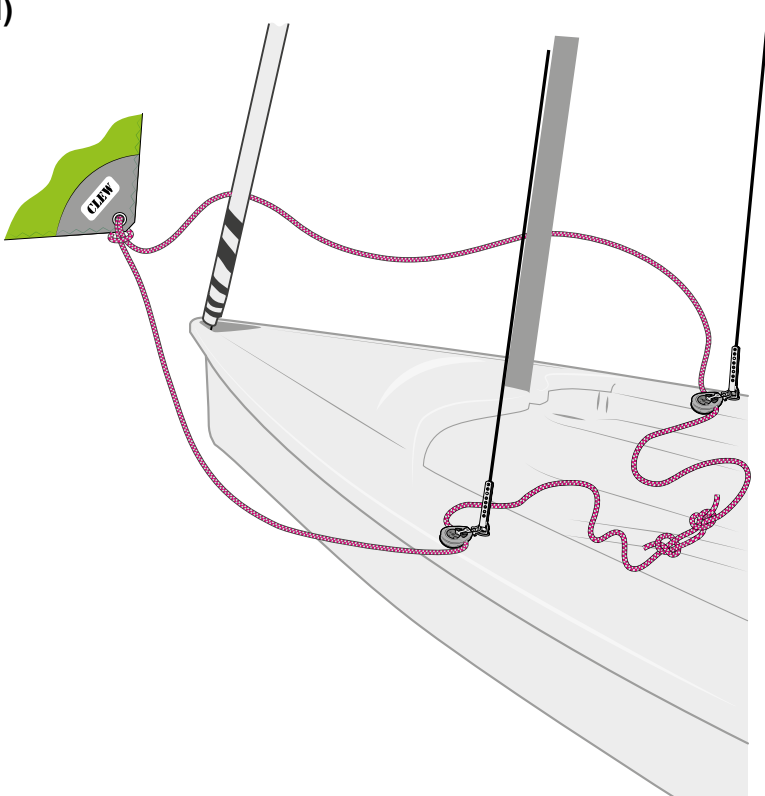

Lead the other gennaker sheet around the Jib luff and through the block on the starboard side. Tie the two ends of the gennaker sheet together.

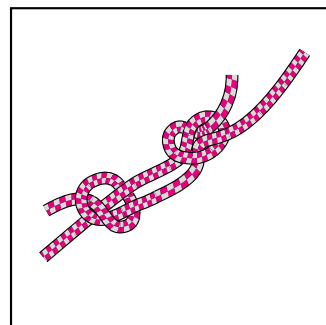

RS Quest 9.2 - Rigging the Symmetrical Spinnaker.

a)

Before stepping the mast you should have attached the spinnaker halyard block to the mast and threaded the spinnaker halyard through it. You should now have two ends of the spinnaker halyard at deck level.

Tie the end of the spinnaker halyard with the plastic bobble on it to the head of the spinnaker.

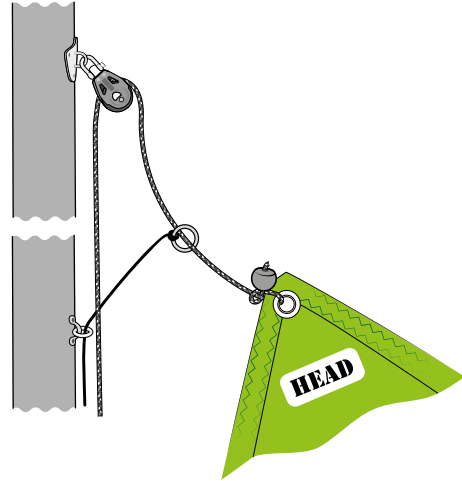

b)

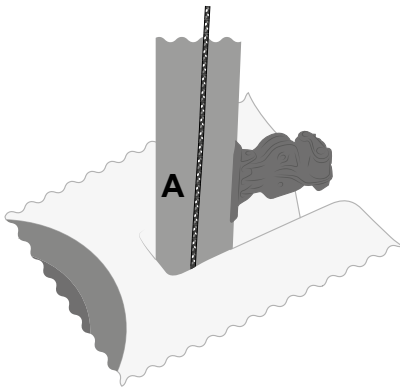

Take the other end of the spinnaker halyard and feed it down the port side of the mast and through the foredeck (if attached) past the mast step.

c)

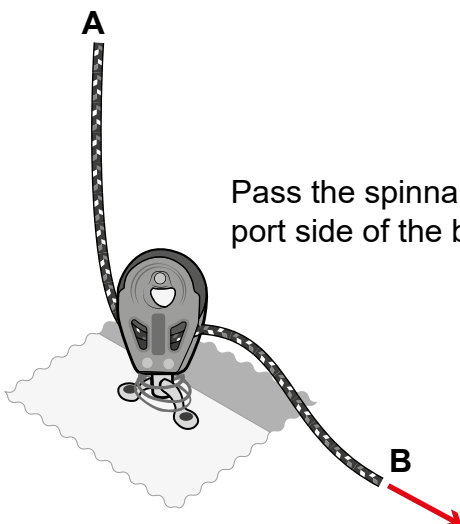

Pass the spinnaker halyard through the 30mm block to the port side of the bowsprit channel, and aft towards the cleat.

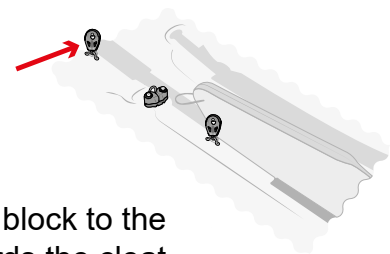

RS Quest 9.2 - Rigging the Symmetrical Spinnaker.

d)

Feed the end of the spinnaker halyard through the cleat and then through the block just to the port side of the centreboard case.

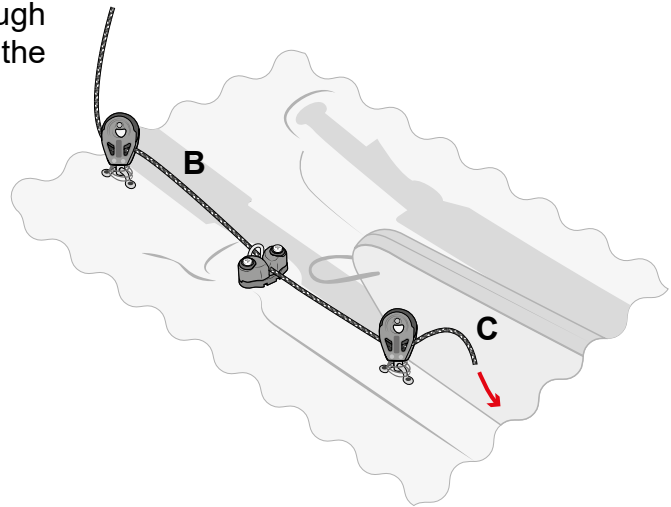

e)

Pass the spinnaker halyard through the block at the aft end of the spinnaker sock and then through the spinnaker sock towards the bow.

You may need to use the tiller extension as an aid to threading the halyard up the spinnaker sock.

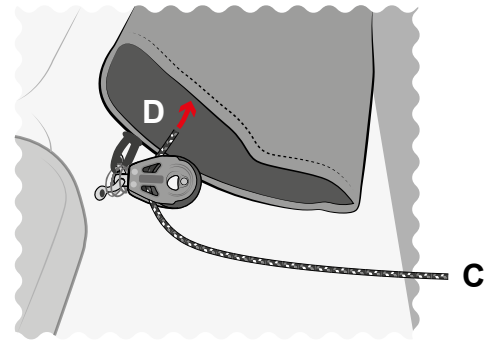

f)

Bring the tail of the spinnaker halyard out through the mouth of the spinnaker sock and pass it through the metal ring on the spinnaker before tying it to the rope eyelet on the back of the spinnaker with a bowline.

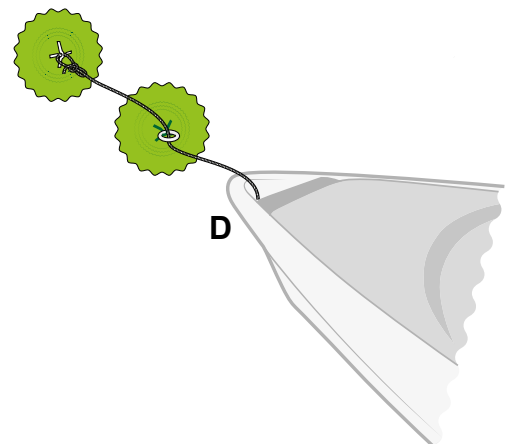

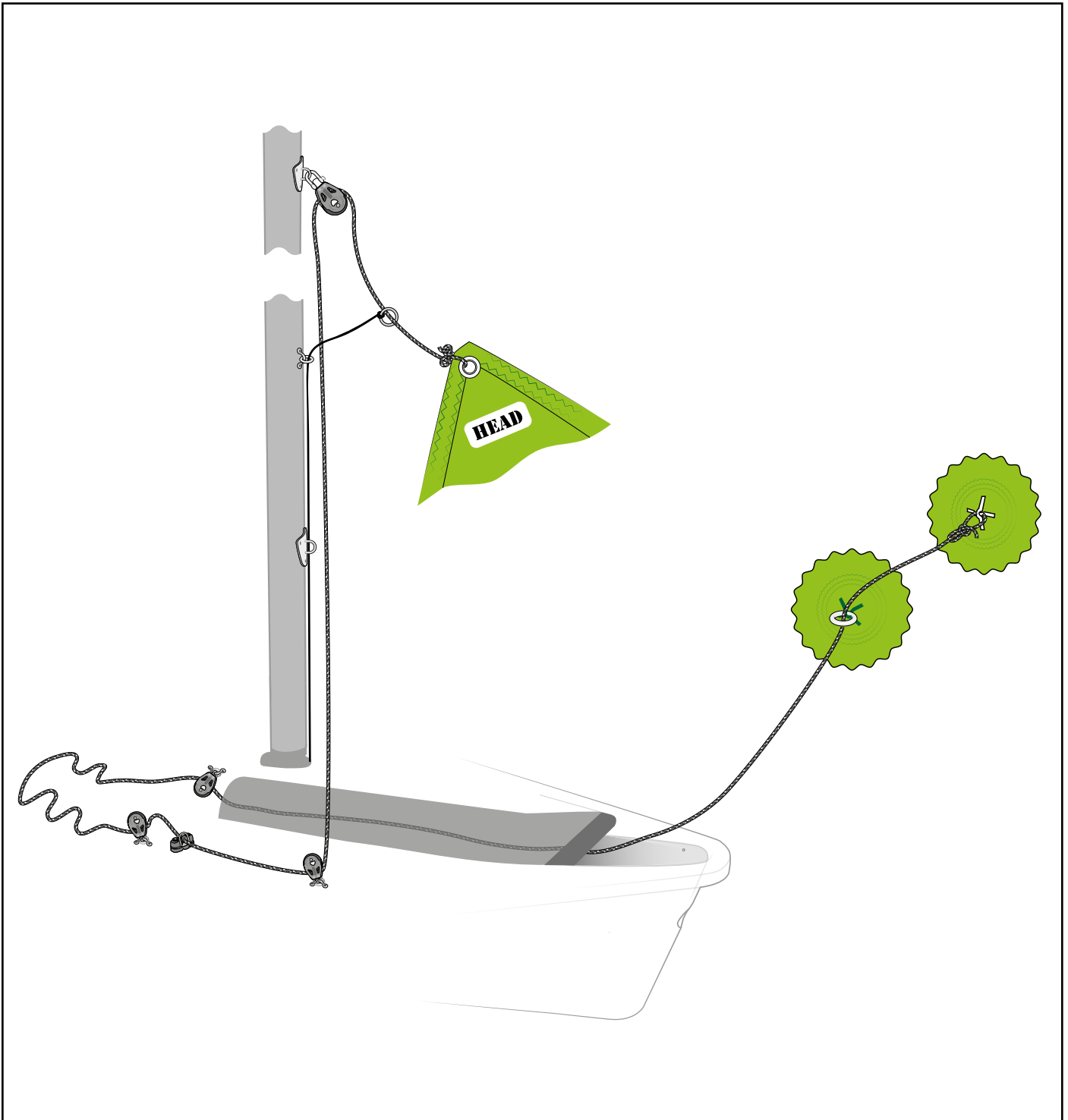

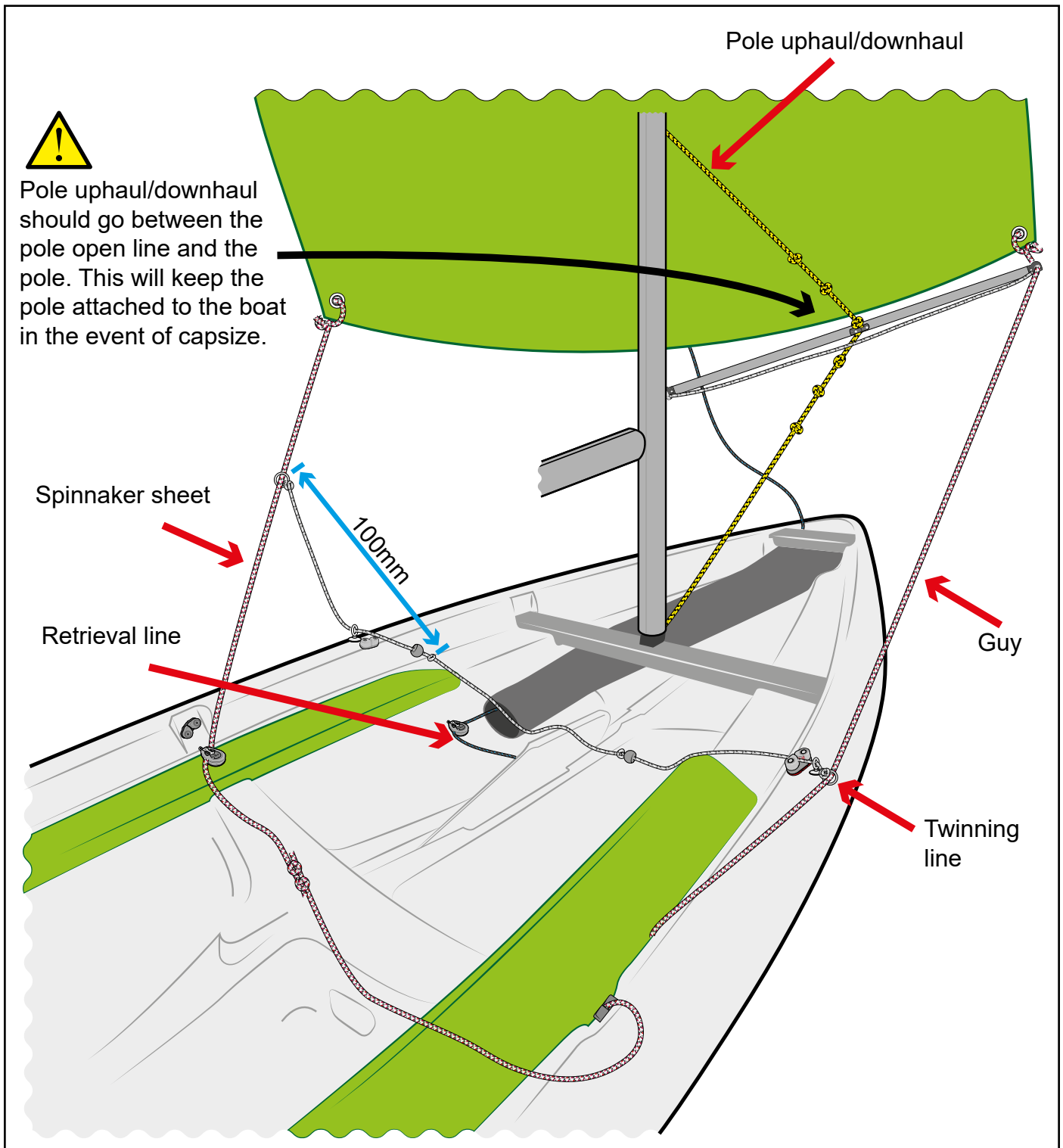

g) Spinnaker pole set up

Put the spinnaker pole between the middle two knots of the yellow uphaul/downhaul and attach the inboard end to the eye on the front of the mast.

There should be about 20mm of slack before the bottom elasticated end of the downhaul comes up against its stop inside the mast. If it is significantly more than this, remove the pole and shorten the uphaul (top end of yellow rope) accordingly. You may also need to adjust the position of the 6 knots in the rope so that the pole is just above horizontal when between the middle two knots.

RS Quest 9.3 - Spinnaker pole.

a)

Remove the two black plastic plugs from the holes on each side of the boom near to the gooseneck joint.

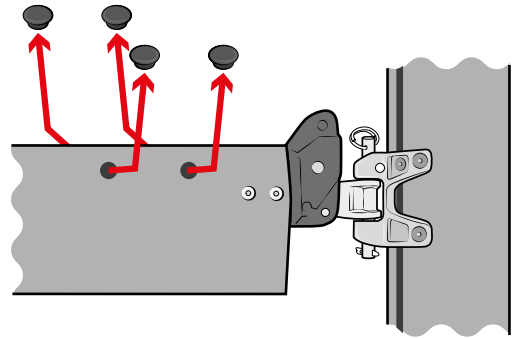

b)

Add one metal eyelet (from the symmetrical spinnaker pack) on each side using the size 10 x 1" pan head screws provided.

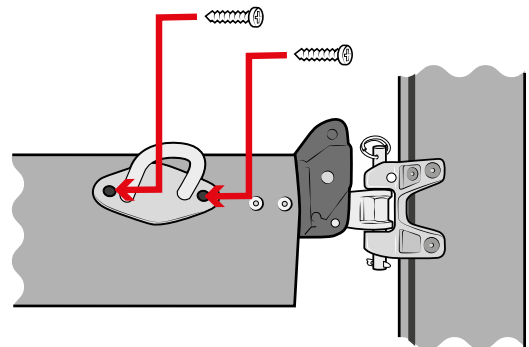

c)

Remove the plastic endcap from the track on the underside of the boom.

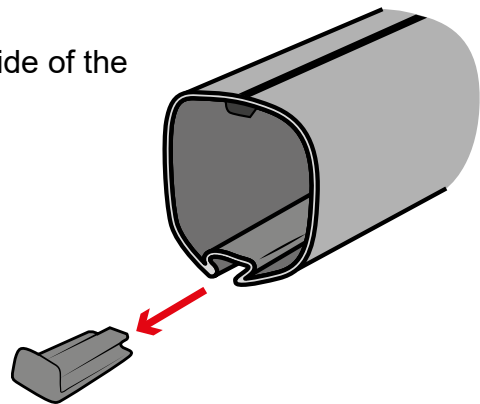

d)

Slide the a small metal eyelet (from the symmetrical spinnaker pack) into the track on the underside of the boom.

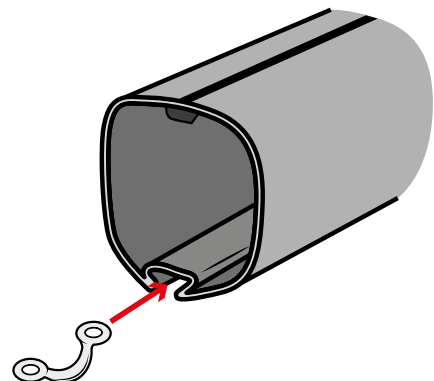

RS Quest 9.3 - Spinnaker pole.

e)

Slide the small metal eyelet along the track on the underside of the boom and line it up with the holes just before the aft mainsheet block.

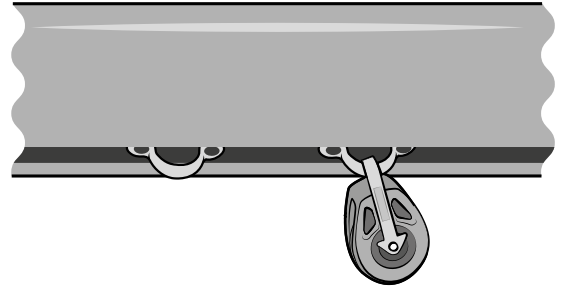

f)

Screw it in using the size 10 x 1" pan head screws provided.

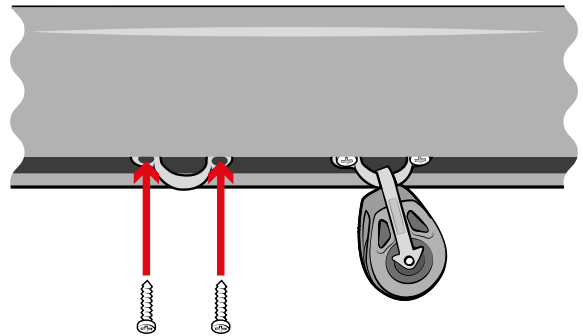

g)

Add the plastic endcap back onto the end of the track on the underside of the boom

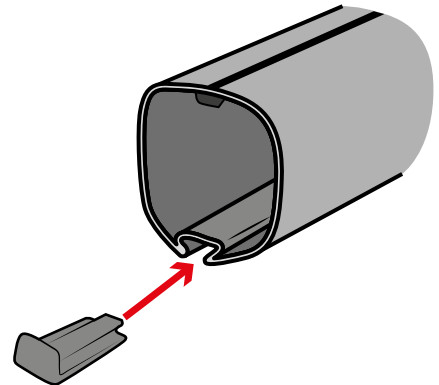

h)

Remove the four black plastic plugs from the holes on top of the boom (approximately 3/4 of the way towards the outboard end of the boom, just forward of the opening in the track).

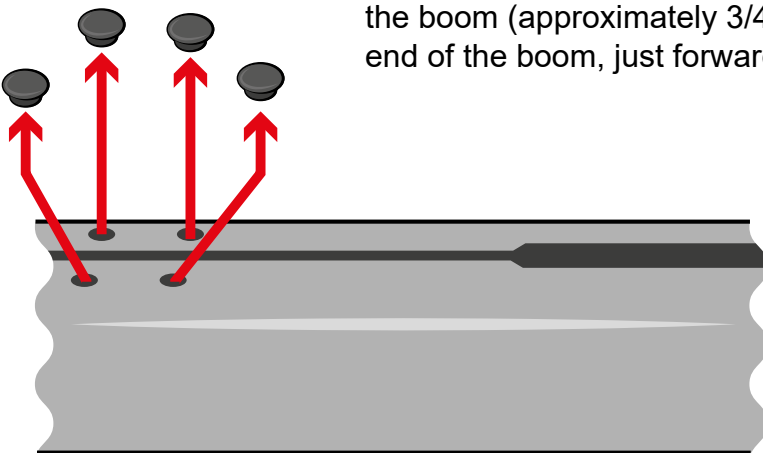

RS Quest 9.3 - Spinnaker pole.

i)

Pass one end of the pole retainer wire through the small metal eyelet so that the wire is half way through.



You might need to loosen the screws slightly to allow this to pass.

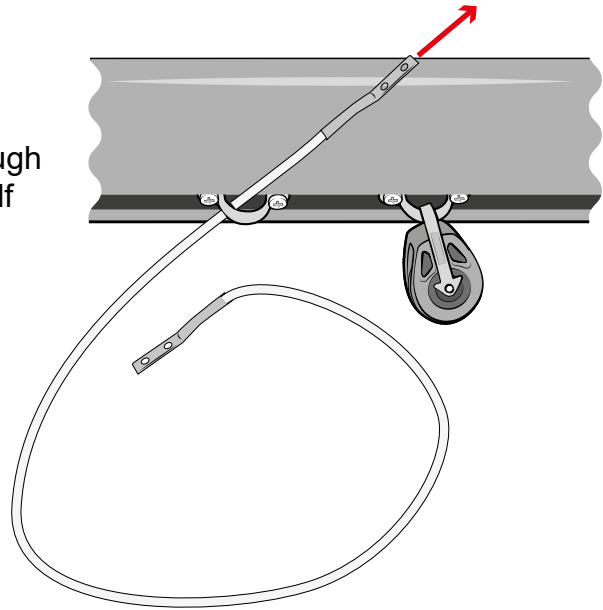

j)

Attach the two ends of the pole retainer wire to the boom using the size 8 x 3/4" screws provided through the four holes on top of the boom (where you removed the plugs in step h).



Get someone to help you hold the boom as you do this or you risk scratching the boom.

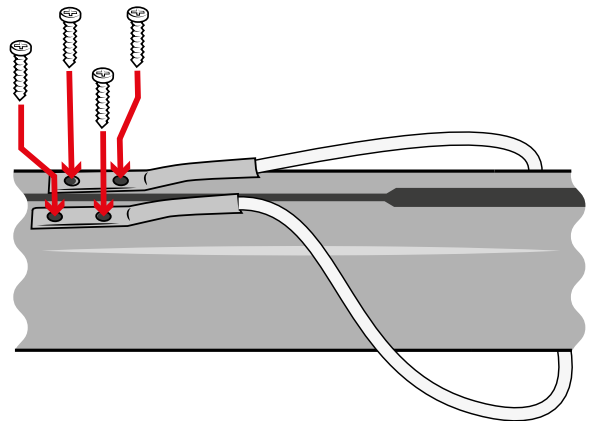

k)

The pole can now be stored on the boom, by posting it inside the pole retainer wire and clipping the end onto one of the metal eyelets.

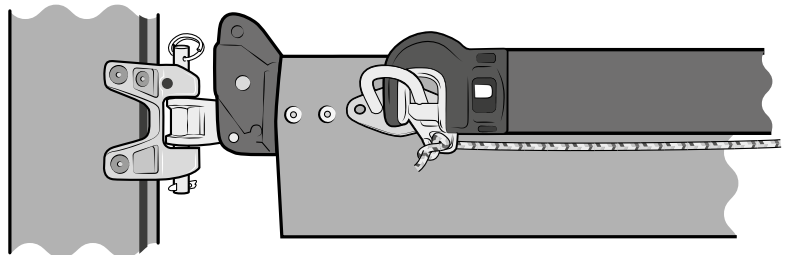

RS Quest

Rigging Guide

10 - Foils

To complete this section you will need:

- The rudder pack
- A large flat-bladed screw driver



PLEASE FOLLOW RIGGING GUIDE IN CORRECT ORDER

a)

In the rudder pack you will find the rudder, tiller, tiller extension and two small flathead screws.

Insert the tiller into the stock. Line up the holes, **making sure that the tiller extension joint is on the top of the tiller**, Then attach using the screws provided.

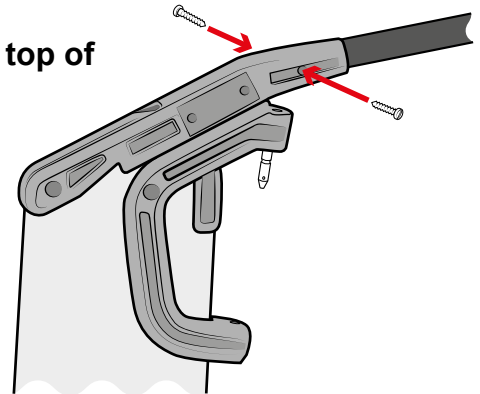
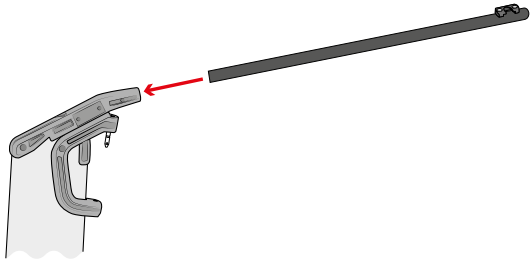

b)

Attach the tiller extension.

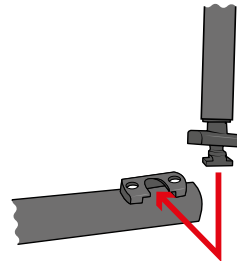

LOCKING GUDGEON
- PUSH TO RELEASE

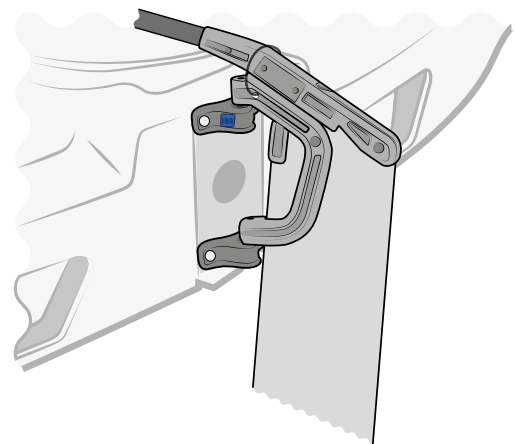
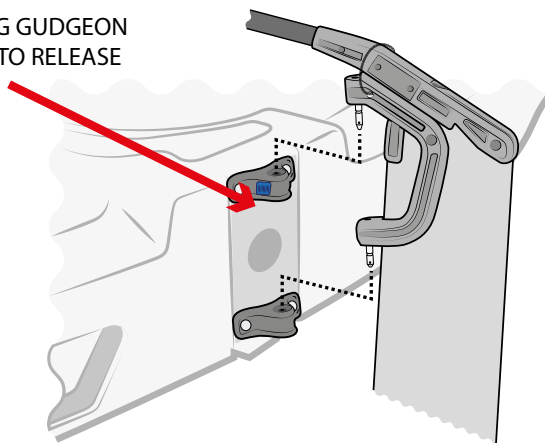

To put the rudder down -

1. Lift the tiller slightly to unlock the blade.
2. Push the tiller aft until the blade is fully lowered (it will normally 'clunk' into the front of the rudder stock).
3. Push the tiller firmly down to 'lock' the blade.

RS Quest 10.1 - Rudder

To pull the rudder up -

1. Lift the tiller slightly to unlock the blade.
2. Pull towards you (into the boat) until the blade reaches it's maximum up position.
3. Push the tiller gently down to hook over the top of the stock.



Do not paddle with the rudder half up.

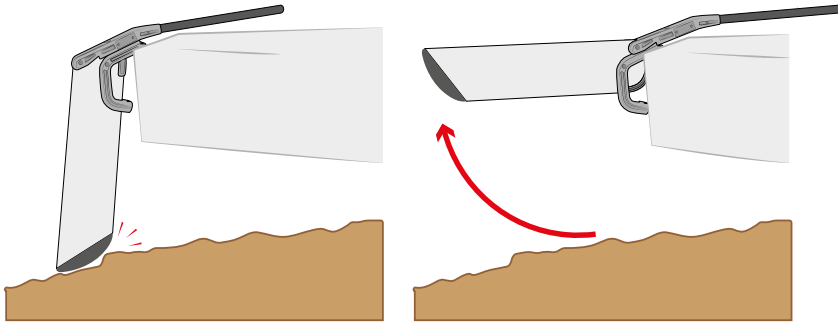

As a safety feature the rudder will unlock and come up if it hits the bottom.

RS Quest 10.2 - Centreboard

a)

The centreboard retainer is a rope with a plastic hook which attaches to a red bungy on the opposite side of the centreboard case.

Un-clip the centreboard retainer.

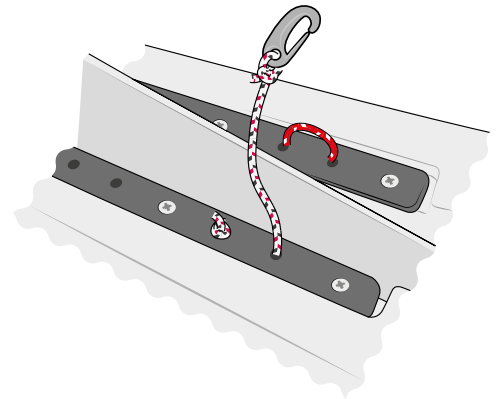

b) When you are in deep enough water, rotate the centreboard into position.

c) If your boat has a rope handle on the centreboard (boats built before April 2017), pass the centreboard retainer through the handle and reattach it to the red bungy.

If your boat does not have a rope handle (boats built April 2017 onwards or older boats with upgrade pack fitted), attach the retainer in front of the board and below the plastic bobbles.

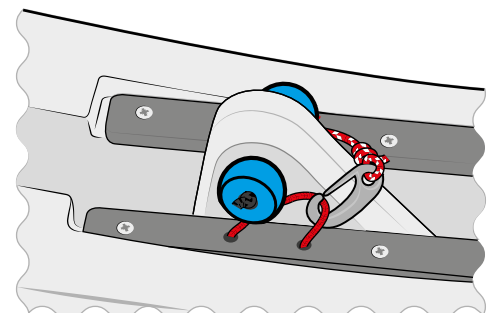
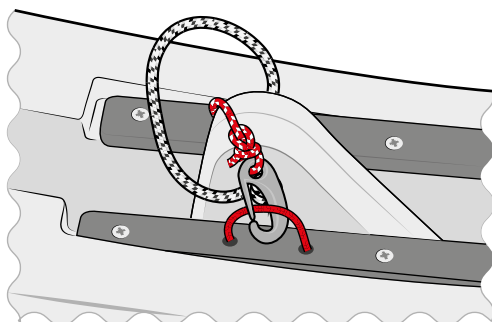

RS Quest

Rigging Guide

11 - Reefing



PLEASE FOLLOW RIGGING GUIDE IN CORRECT ORDER

RS Quest

RS Quest 11.1 - Rigging your reefing line.

Reefing enables the less-experienced or younger sailor to continue sailing in stronger winds.

Please follow the instructions for reefing, ensuring that the reefing line is threaded the correct way through the mainsail.

a)

Tie one end of the reefing line to the eyelet on the end of the boom (on top) with a bowline.

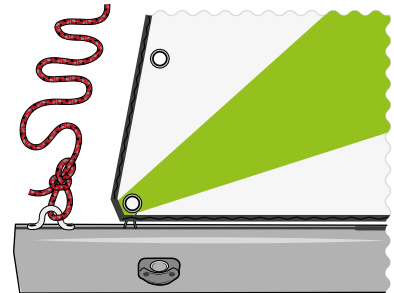

b)

Pass the other end of the reefing line through the cringle on the leech of the mainsail.

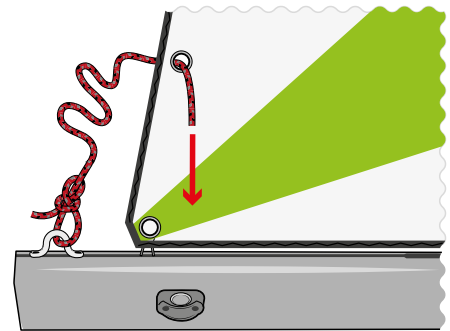

c)

Pass the end of the reefing line back through the eye on the end of the boom (on top).

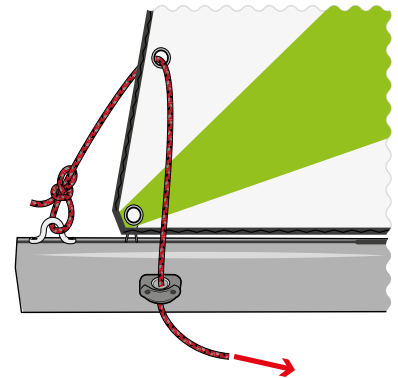

d)

Pass the end of the reefing line back along the boom to the cleat as shown then tie a figure of eight in the end.

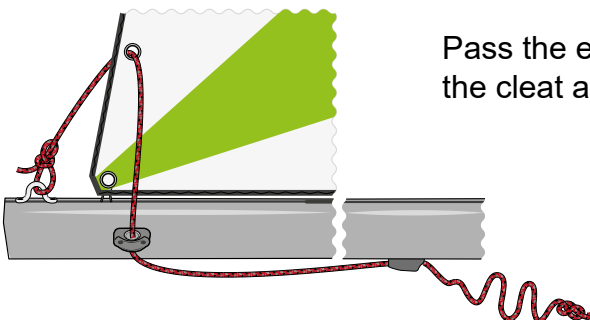

RS Quest 11.2 - Reefing the mainsail

a)

One person may reef the mainsail while sailing on a close reach, sails eased, on a starboard tack.

Make sure you are in plenty of clear water while reefing.

b)

Ease the main halyard.

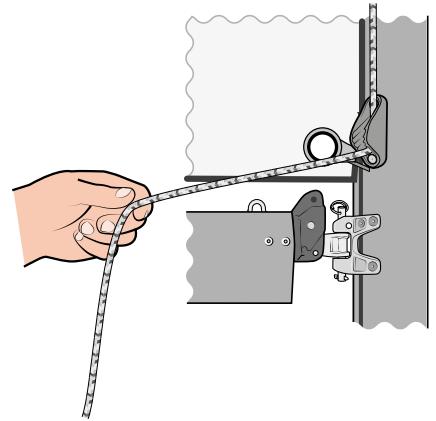

c)

Pull the reefing line tight.

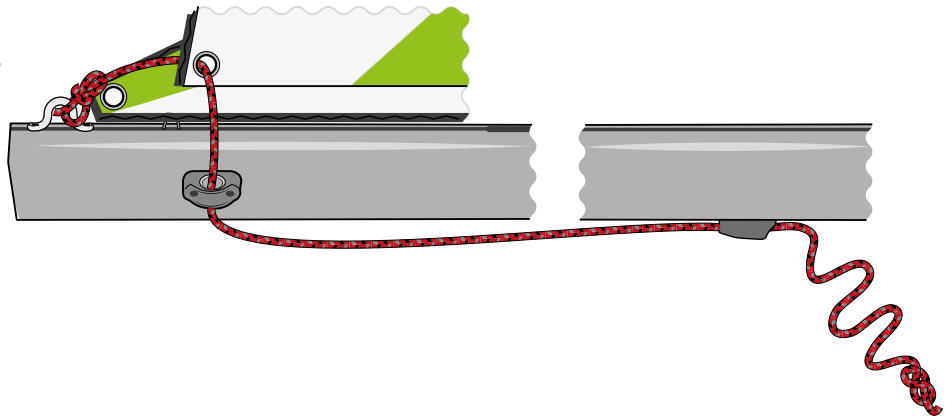

d)

Make sure the reefing clew slug is inserted into the track on the mast.

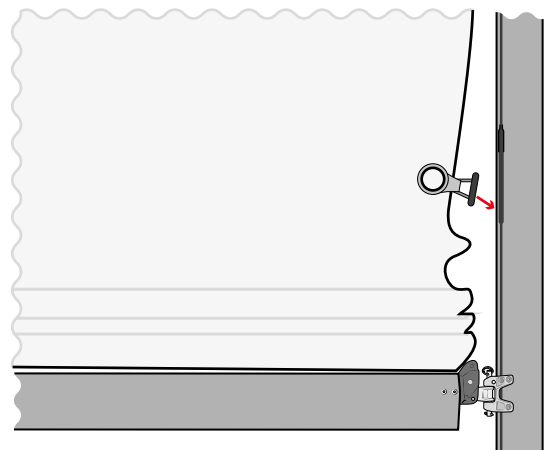

RS Quest 11.2 - Reefing the mainsail

e)

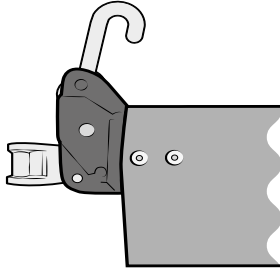

There is a hook on the boom gooseneck joint.

Pull down the luff of the mainsail to allow you to get this hook through the ring attached to the second cringle on the luff of the mainsail.

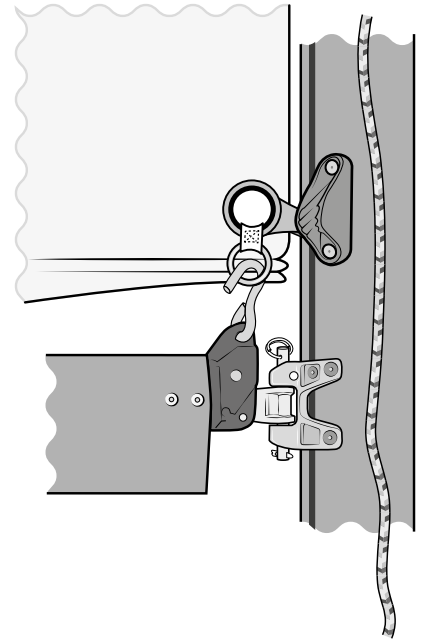

Note: From April 2017, new boats will be provided with a different hook which makes this step easier. The new style of hook is included in the RS Quest Upgrade Pack.



f)

Re-tension the main halyard and cleat it off.

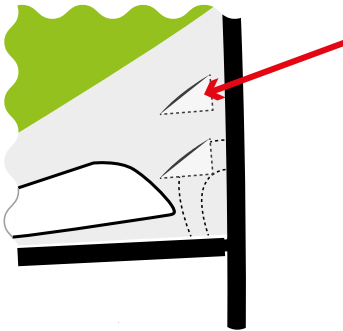

Use the second pouch on the mainsail for the main halyard tail.

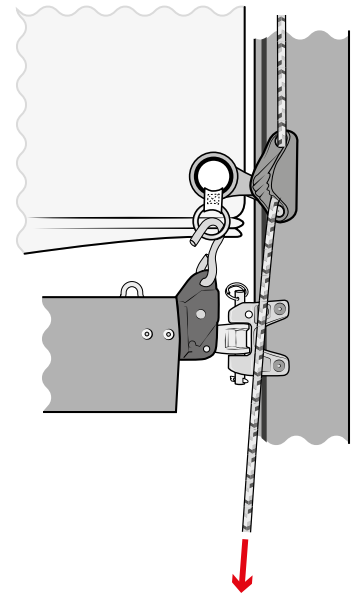

g) The sail is now reefed. You can tie the elastic (found in the rigging pack) through the cringle in the middle of the mainsail (not around the boom) to hold the reefed part of the sail in place.



Do not tie the elastic or any line through the reefing eyelets and around the boom as you risk tearing the sail.

HINT

The jib is a very effective strong wind sail area because it is low down and maintains a balanced helm. So slab reef before you lose the jib – it's more fun for the crew!

RS Quest

Rigging Guide

12 - Trapeze Kit

Contents:

- 2 x trapeze wires and adjuster
- 1 x elastic takeup
- 1 x lowers
- 2 x shackles
- 2 x length of rope

The trapeze pack contains shrouds with trapeze wires attached which will replace the shrouds on an existing boat. This must be done with the mast laying flat and before stepping the mast in the boat. The lowers must be fitted when trapezing



MAXIMUM TRAPEZE WEIGHT 80kg



The chance of entrapment is increased with the use of trapeze equipment. The lowers, trapeze rings and harness hooks all contribute to the change in risk. Please ensure the crew, safety equipment and any additional support is suitable for the environment before venturing afloat.



RS

Quest

a)

Attach the two shrouds to the mast.

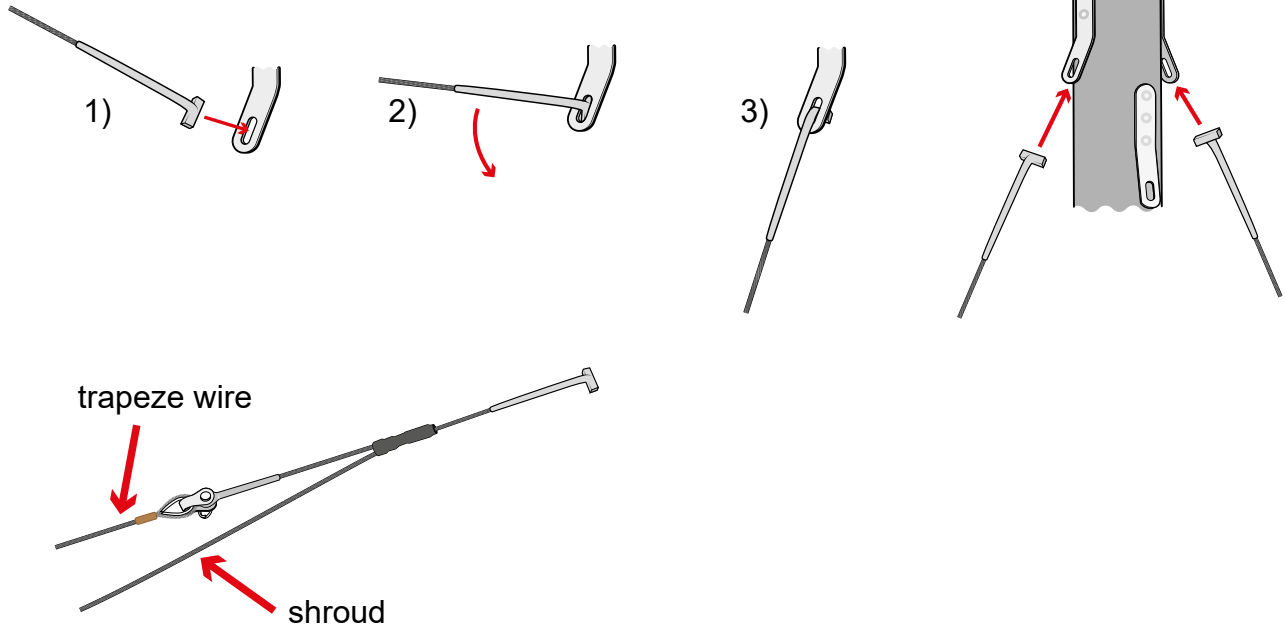

- b) Continue to rig and step the mast **as described in section 6 of the RS Quest rigging manual**. If you have lost your original rigging manual you can download a new copy from the RS Sailing website.

c)

Take the trapeze elastic and tie a bowline in one end.

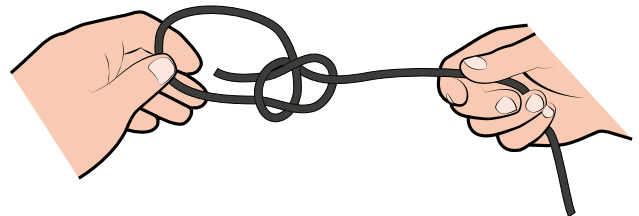

d)

Feed the other end through the port shroud eye bolt (from outside towards the middle of the boat).

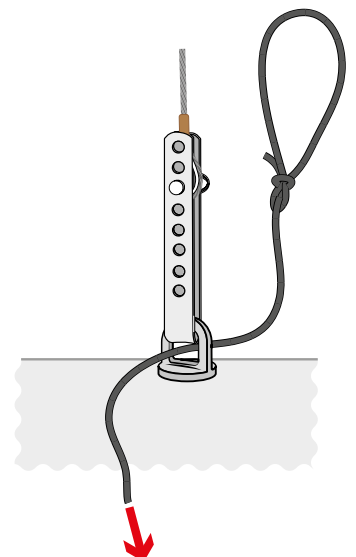

RS Quest 12 - Trapeze Kit

e)

Pass the end through the plastic toestraps retainers as shown.

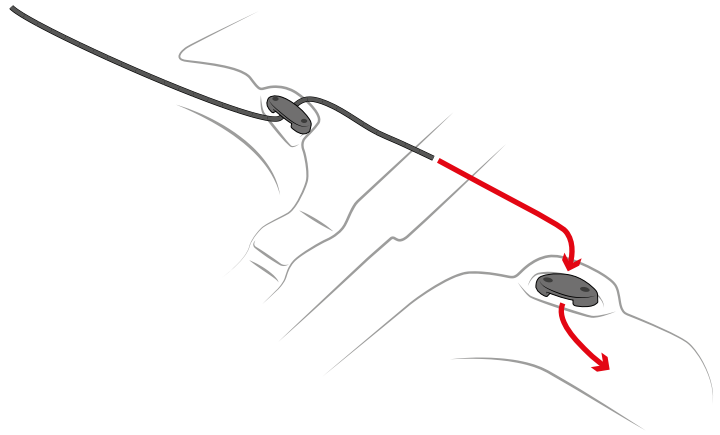

f)

Feed the end through the starboard shroud eye bolt (away from the centre of the boat) and tie a bowline in the end.

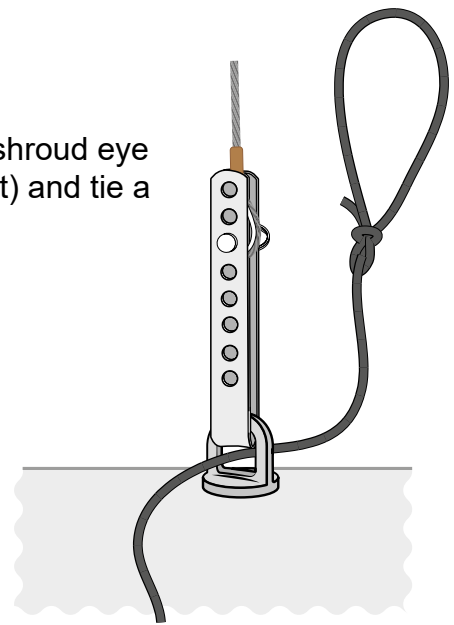
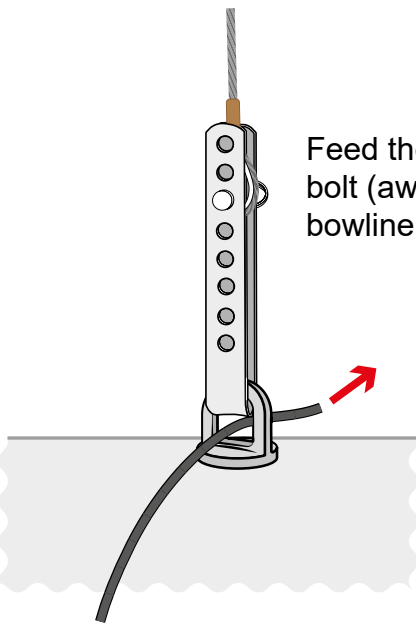

g)

Connect the trapeze wires to the elastic.

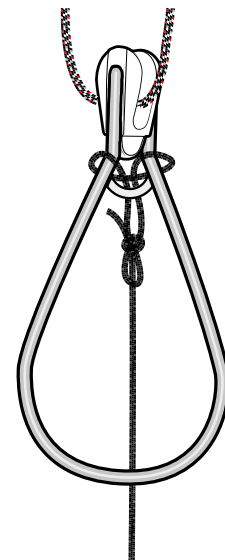
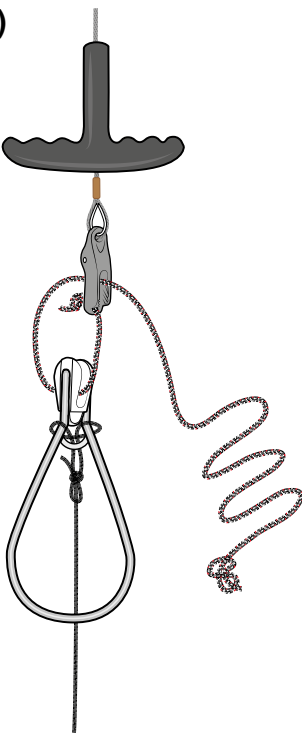

h)

**VERY IMPORTANT****Adding the lowers**

Shackle the lowers onto the spinnaker pole eye on the front of the mast

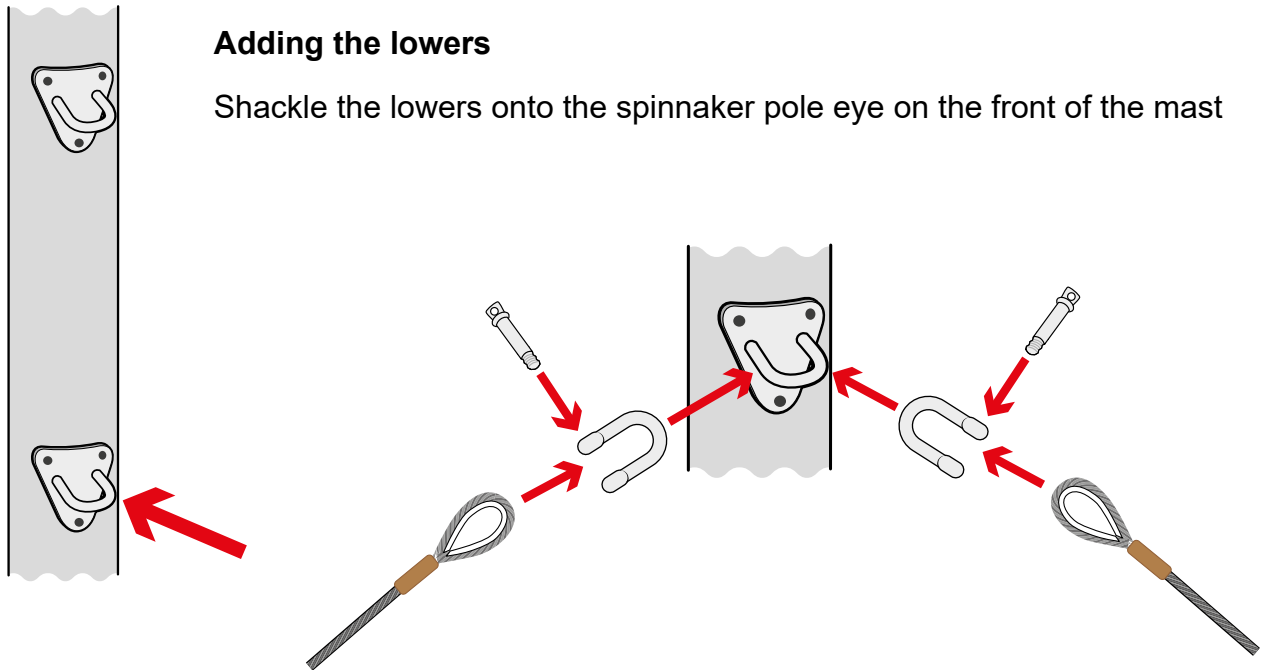

i)

Lash the lowers tightly onto the shroud eye bolts using the lengths of rope provided.

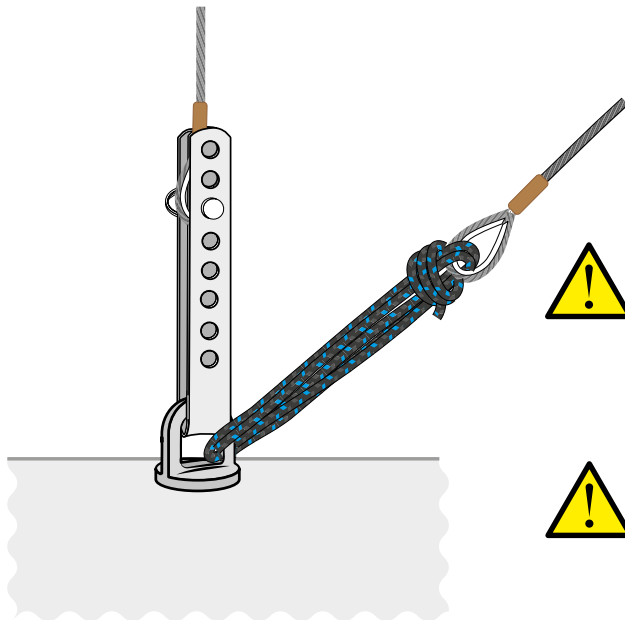

Make sure that even weight is added to the lowers.



Lowers must be tightened after the rig is tensioned.

**MAXIMUM TRAPEZE WEIGHT 80kg**

RS Quest

Rigging Guide

13 - Outboard bracket



PLEASE FOLLOW RIGGING GUIDE IN CORRECT ORDER

RS Quest

RS Quest 13 - Outboard Bracket

The optional outboard bracket pack contains:

Outboard bracket

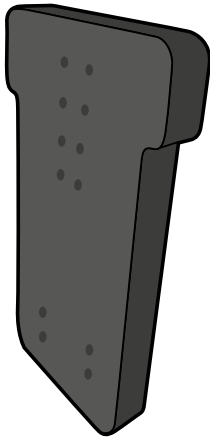

Pintle



Bolts, nuts and washers x 4



Eye bolts x 2



a)

First bolt the pintle to the outboard bracket through the second and third row of holes as shown.

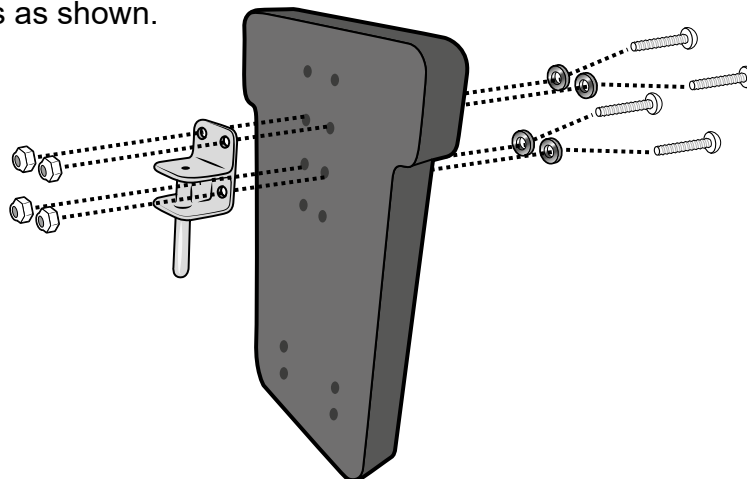

The outboard bracket is universal and can be set up in different ways for different RS boats, so it is important that you assemble it correctly or it will not fit the Quest.

b)

Fit the outboard bracket to the boat by dropping the pintle into the hole on the top of the transom on the starboard side.

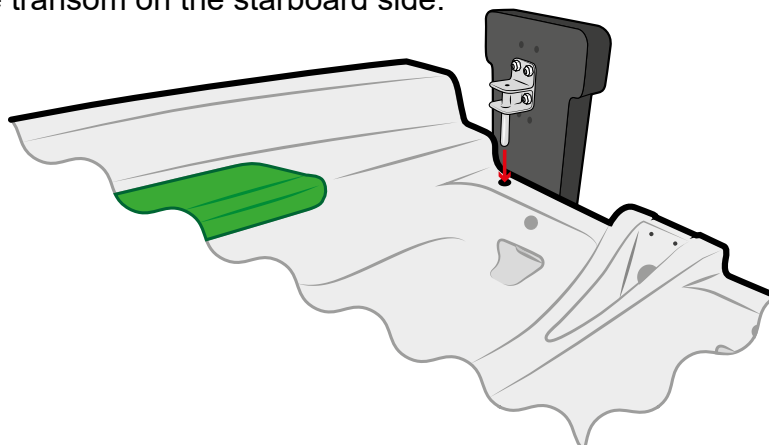

RS Quest 13 - Outboard Bracket

- c) If you have assembled the bracket correctly, the bottom two holes on the outboard bracket should now line up with two threaded inserts on the aft face of the transom.

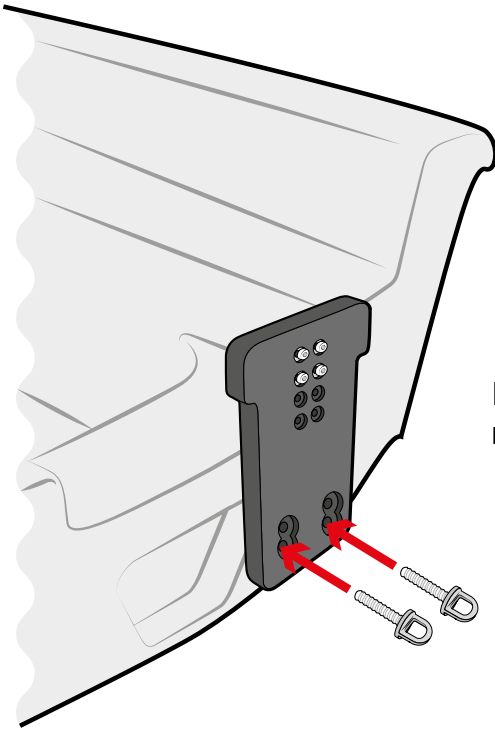

Insert the two eye bolts and tighten by hand. You are now ready to attach an outboard motor to the Quest.

RS Quest

Rigging Guide

14 - Sailing Hints



PLEASE FOLLOW RIGGING GUIDE IN CORRECT ORDER

RS Quest

14.1 Introduction

The RS Quest is a very rewarding boat to sail – to fully appreciate its handling, you should be comfortable with the basic techniques of sailing small boats. If you lack confidence or feel that a refresher is in order, there are many approved sailing schools which can be recommended. See www.rya.org.uk for more information.

While we offer you a few hints to aid your enjoyment of your new boat, they should not be considered as a substitute for an approved course in dinghy sailing. In order to build your confidence and familiarise yourself with your new boat, we recommend that you choose a fairly quiet day with a steady wind for your first outing.

14.2 Launching

With the sails fully hoisted, and the rudder attached, the boat should be wheeled into the water, keeping it head to wind as far as possible. If you have a crew, s/he can hold the boat head to wind whilst the trolley is stowed ashore.

TOP TIP

If the tide is coming in as you launch, make sure that you leave the trolley far enough up the beach that it will not be swept away.

14.3 Leaving the Beach

The easiest way to get going is for the helm to step aboard while the crew holds the boat. The helm should put a little centreboard down, then move back to his normal position and lower some of the rudder blade. Then, s/he may instruct the crew to push the bow off the wind and climb in. The crew will then lower the centreboard as depth allows. As soon as the water is deep enough, the centreboard should be fully lowered, and the retaining elastic clipped to the rope handle to prevent it retracting into the hull in the event of a full inversion.

TOP TIP

If you are using the jib, pulling this sail in as you leave the beach will ensure that the bow continues to swing away from the direction that the wind is blowing from.

As soon the water is deep enough, make sure that you lower the rudder blade fully. You will know it is fully down if you feel a gentle “thud” as the front face of the blade hits the front face of the stock. Push the tiller down to lock the blade. Pull the sail in and you are away! For the best performance, you should ensure that you and your crew position yourselves so that the boat is sailing through the water as upright as possible.

TOP TIP

As a general rule, sit further forward in lighter winds and further aft in stronger breezes.

14.4 - Sailing Close-Hauled and Tacking

When sailing close-hauled, or as close as possible to the wind, it is important to get the boom as near as possible to the centreline, especially when sailing the with the mainsail and jib. The kicking strap should be firmly tensioned for upwind work.

The jib sheet should be pulled in fairly hard when sailing upwind – tighter in stronger winds and less so in lighter winds. Sail to the jib tell-tails, keeping the one on the back of the sail streaming and the one closest to you either streaming or lifting upwards slightly.

To tack, push the tiller extension away from you and, as the boat starts to turn, step across the cockpit facing forwards. Once the boat has completed the turn, bring the tiller back into the centre before sitting down on the new side, with the tiller extension behind your back. When you are settled, swap the mainsheet and the tiller extension into the new hands.

If the boat slows right down and feels lifeless when close-hauled, you could be sailing too close to the wind. Ease the mainsheet and 'bear off' ie. turn away from the wind for a while to get the boat going again.

14.5 - Sailing Downwind and Gybing

When sailing downwind, both sails should be let out as far as possible. To gybe, pull the tiller towards you and, as the boat starts to turn, step across the cockpit facing forward. Once the boat has completed the turn, bring the tiller back into the centre before sitting down on the new side, with the tiller extension behind your back. Often, the boom will not want to come across until you have nearly completed the gybe, so it often pays to give the mainsheet a tweak to encourage the boom over at the moment that you want it to come! Don't forget to duck your head as the boom comes over. Once you are settled, swap the mainsheet and the tiller extension into the new hands.

14.6 - Using the Gennaker

If you are inexperienced in using a gennaker, choose a fairly quiet day for your first excursion. A gennaker nearly doubles your sail area, and should be treated with a healthy degree of respect!

For your first hoist you should be sailing downwind on a broad reach, with the wind coming over the helm's aft shoulder. The crew should sit in the centre of the boat, astride the centreboard case, and hoist the gennaker by pulling the gennaker halyard from the port side of the centreboard.

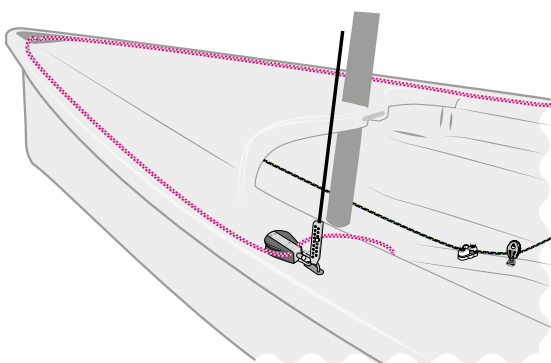

The gennaker halyard pulls the bowsprit out at the same time – when the gennaker is hoisted, you are ready to go. The crew, or the helm if sailing singlehanded, should now pull gently on the leeward gennaker sheet until the gennaker has filled. Gennakers may be effectively used from a close reach to a broad reach so, to get downwind, one should become adept at gybing. It is not possible to tack with the gennaker hoisted. For the best effect, the gennaker sheet should always be eased as far as possible, so that the luff is just on the point of curling.

Gybing with the gennaker is fairly straightforward. Like the jib, it should be pulled across at the same time as the mainsail comes across. As soon as it has been pulled in and filled with wind, it should again be immediately eased for maximum efficiency and speed

To drop the gennaker, reverse the procedure used to hoist. The boat should be sailing on a broad reach, and the slack in the gennaker downhaul is pulled in from the left hand halyard block. As the gennaker downhaul goes tight, the gennaker halyard should be popped out of the cleat. Then, pull the remainder of the gennaker downhaul through until the gennaker is pulled sharply into the chute. Dropping the gennaker on tighter reaches is harder, and requires more effort on the gennaker downhaul.

TOP TIP

Tie a rope bobble onto the gennaker halyard, about 10 cm from the bowline that is attached to the head of the gennaker. This will make dropping the gennaker easier.

HINT

The gennaker can “bunch up” when entering the chute. This can be minimised by keeping some tension on the gennaker sheet, preventing the clew from being sucked into the chute with the main body of the gennaker.

When the gennaker is fully lowered, tidy the sheets and the halyard to keep the cockpit area clear.

14.7 - Using the Symmetrical Spinnaker

As with the gennaker, it is best to first sail with the spinnaker on a quiet day.

Hoisting-

Bear away (turn downwind) until the boat is almost on a run. If on starboard tack unhook the pole from the boom. With your right hand pick up the windward spinnaker sheet (the guy) from in front of the shrouds. Open the jaw on the front of the spinnaker pole with your left hand and place the guy in the pole (making sure it is not twisted). Lift the pole forward and hook the knotted yellow uphaul in the V jammer in the centre of the pole. If it is windy you want the pole to be high and conversely if it is light the pole should be low.

Continue pushing the pole out and hook it onto the eye on the front of the mast. Pull on the guy through the ratchet block. Pull a couple of feet of the clew of the spinnaker out of the chute. Cleat the guy. Check the sheet to leeward is not tangled and is out of it's cleat. Check the windward twinning line is cleated and the leeward one uncleated. The spinnaker is now ready to hoist. Stand over the halyard block and pull the spinnaker up as fast as possible. When it is fully up the bobble on the halyard will reach the mast. Sit down, pull the guy in and cleat it. The closer to a dead run you are, the further back the pole has to come. As a rough guide, it should be almost opposite the angle of the boom.

Pull on the spinnaker sheet until it fills. Ideally the luff (windward side of the spinnaker) should be just on the edge of curling. With a little practice the helm can help the crew with many of the tasks. Once settled on a run it can be beneficial for the helm to sit to leeward allowing the crew to have a better view of the spinnaker.

Gybing Starboard to Port-

Bear away onto a dead run, pulling on the guy to bring the pole aft. Cleat the guy and the sheet with the spinnaker fully set. It is the helm's job to steer to keep the spinnaker full in this situation. Pull down gently on the now port twinning line until it is fully in. You are now ready to gybe.

Continue bearing away. The helm should grab the mainsheet to help the boom across in the same procedure as if the spinnaker isn't there. Once the boom is across, make sure you readjust your course to be close to a run. Once you have settled down, the crew can now reach forward and unhook the pole from the mast. Pass the pole from behind the mainsail up to windward, ensuring that the yellow uphaul moves across the double V cleat. Pull on the string connecting the plungers to release the old guy. Once this is done, grab the new guy (on the port side) in front of the shrouds in your left hand and hook it in to the end of the pole. Push the pole out as when hoisting and hook it onto the mast. Let go of the starboard twinning line. Pull the new guy through the ratchet block and cleat. Settle down and enjoy the ride!

Lowering the Spinnaker-

To lower the spinnaker ease the guy forward. Uncleat the halyard and pull hard on the retrieval line inboard of the port side tank. When the spinnaker is half down, let go of both the sheet and the guy. Continue pulling the spinnaker into the sock. Only when the spinnaker is fully in the sock, stand up and unhook the pole, followed by the yellow uphaul/downhaul rope. Stow the pole on the windward side of the boom, unhooking the guy as you do so. When the spinnaker is fully lowered, tidy the sheets and the halyard to keep the cockpit area clear. You are now ready to sail upwind again.

Bowline

The bowline is a reliable knot used for tying a loop in rope. It is extremely strong when under load, and unties easily once free of load. Some people use the rhyme “the rabbit comes out of the hole, round the tree, and back down the hole” as a way of remembering how to tie a bowline.

Take the end of the piece of rope and assess how big a loop you require

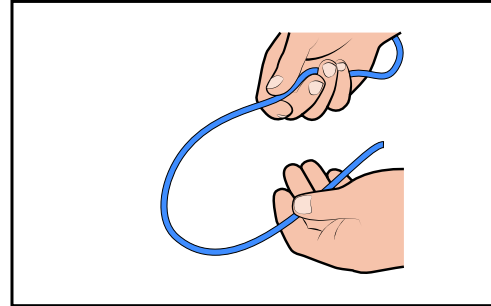

Make a small loop in the rope

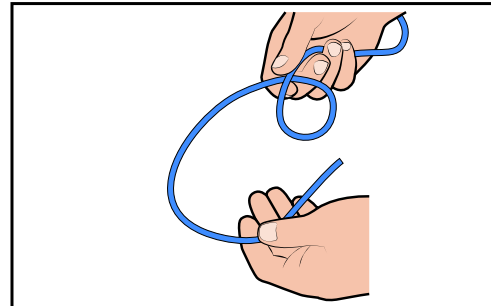

Take the tail and lead it up through the loop

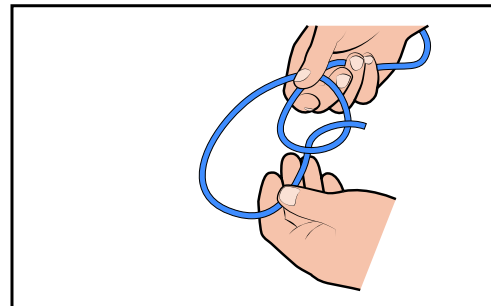

Pass the tail around the standing rope

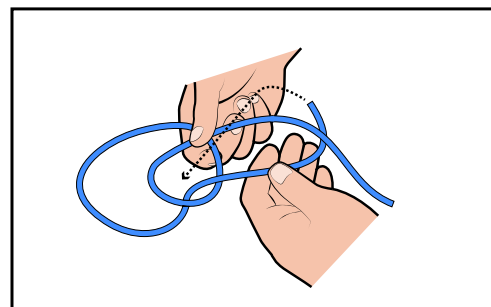

Thread the tail back through the loop, and tighten

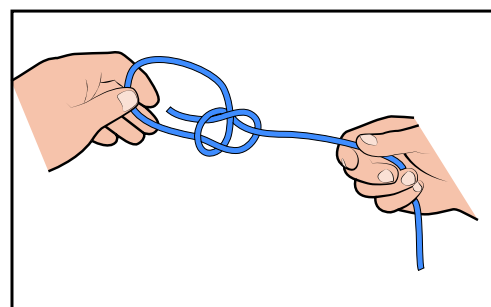

Knot-on-knot

A 'knot-on-knot' is useful for tying the end of a rope to a sail or a fitting, and is particularly reliable due to the manner in which the rope binds upon itself.

Tie a single overhand knot in the end of the rope. Feed the rope through the sail or the fitting, and tie another overhand knot in the rope.

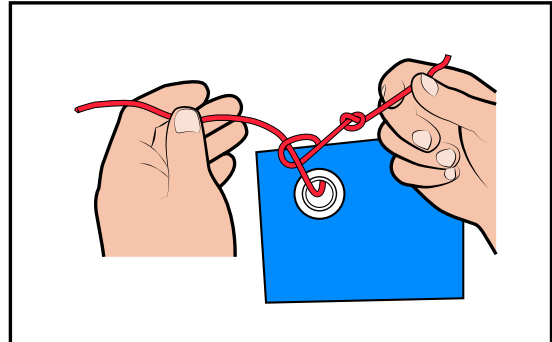

Pull the rope tight so that the rope binds on the original overhand knot.

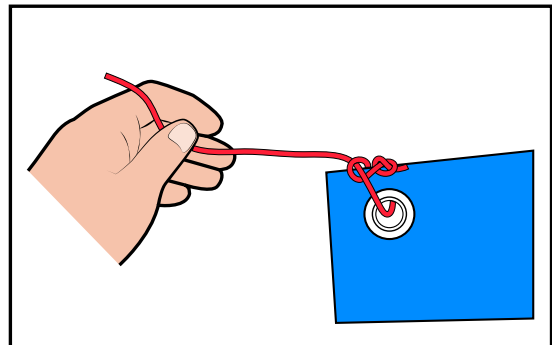
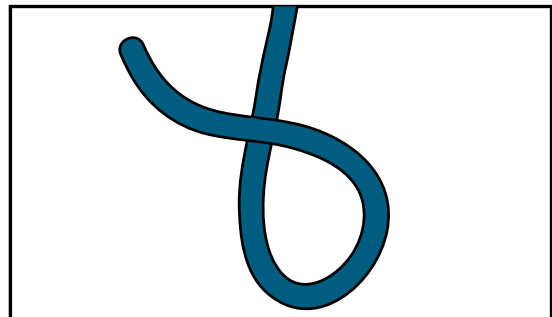

Figure-of-Eight

The 'figure-of-eight' knot is used as a stopper knot, preventing ropes from slipping through fittings. Like the bowline, the 'figure-of-eight' knot unties easily once free of load.

Make a loop in the end of the rope



Lead the tail underneath the standing end of the rope

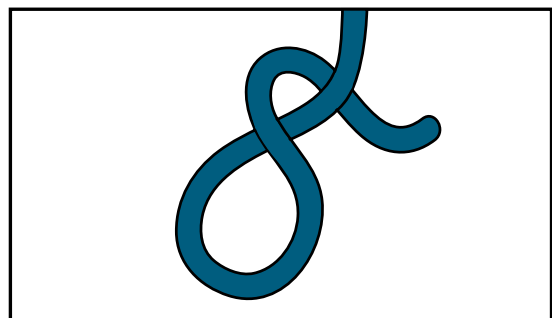

Lead the tail of the rope back through the loop, and tighten

